



A STEEL PARTNERS COMPANY

Matrix[®] AP

208V – 690V

TECHNICAL REFERENCE MANUAL



WARNING

High Voltage! Only a qualified electrician can carry out the electrical installation of this filter.

Quick Reference

1	Performance Data	Pages 5 - 14
2	Selection Guide	Pages 15 - 25
3	Installation Guide	Pages 26 - 42
4	Start-up/Troubleshooting	Pages 43 - 47

This page intentionally left blank

TABLE OF CONTENTS

1. SAFETY	1
WARNINGS AND CAUTIONS	1
GENERAL SAFETY INSTRUCTIONS	2
2. GENERAL INFORMATION	3
RECEIPT & REPAIR STATEMENT	3
ENCLOSURES	4
WARRANTY	4
3. MATRIX AP PERFORMANCE DATA	5
PERFORMANCE SPECIFICATIONS	5
FILTER EFFICIENCY + WATT LOSS.....	6
FILTER EFFICIENCY + WATT LOSS.....	7
LOAD EFFECT ON THID.....	11
TYPICAL HARMONIC SPECTRUM.....	11
TYPICAL PERFORMANCE WITH UNBALANCED LINE VOLTAGE	12
ALTITUDE DERATING	13
TEMPERATURE DERATING	13
VOLTAGE DISTORTION DERATING CURVE	14
4. HOW TO SELECT	15
SELECTION GUIDE	15
UNDERSTANDING THE MATRIX AP PART NUMBER:	16
MATRIX AP 208-240 VOLTS, 60HZ SELECTION TABLES	17
MATRIX AP 208-240 VOLTS, 60HZ SELECTION TABLES	18
MATRIX AP 380-415 VOLTS, 50HZ SELECTION TABLES	19
MATRIX AP 380-415 VOLTS, 50HZ SELECTION TABLES	20
MATRIX AP 480 VOLTS, 60HZ SELECTION TABLES	21
MATRIX AP 480 VOLTS, 60HZ SELECTION TABLES	22
MATRIX AP 600 VOLTS, 60HZ SELECTION TABLES	23
MATRIX AP 600 VOLTS, 60HZ SELECTION TABLES	24
MATRIX AP 690 VOLTS, 50HZ SELECTION TABLES	25
5. HOW TO INSTALL	26
INSTALLATION CHECKLIST	26
GROUNDING	27
POWER WIRING CONNECTION	28
BASIC SCHEMATIC DIAGRAM	30
OPEN PANEL UNIT INTERCONNECTION DIAGRAM	31
ENCLOSED UNIT INTERCONNECTION DIAGRAM	32
CONTACTOR OPTION	33
CONTACTOR COIL SWITCHING CURRENTS.....	37
TORQUE RATINGS MATRIX AP 208V-240V.....	38
TORQUE RATINGS MATRIX AP 380V-415V.....	39
TORQUE RATINGS MATRIX AP 480V	40
TORQUE RATINGS MATRIX AP 600V	41
TORQUE RATINGS MATRIX AP 690V	42
6. START-UP	43
SAFETY PRECAUTIONS.....	43
7. TROUBLESHOOTING	45
MATRIX AP HARMONIC FILTER FIELD CHECKS.....	46

List of Figures

Figure 3-1: Load Effect on THID	11
Figure 3-2: Typical Harmonic Spectrum with and without Matrix AP	11
Figure 3-3: Power Factor	12
Figure 3-4: Altitude Derating Curve	13
Figure 3-5: Temperature Derating	13
Figure 3-6: Voltage Distortion Derating Curve	14
Figure 5-1: Basic Schematic Diagram	30
Figure 5-2: Open Panel Interconnection	31
Figure 5-3: Enclosed Interconnection	32
Figure 5-4: Contactor Option – 002	33
Figure 5-5: Contactor Option – 009	34
Figure 5-6: Contactor Option – 012	35
Figure 5-7: Contactor Option – 013	36



List of Tables

Table 3-1: Performance Specifications	5
Table 3-2: Watt Loss - Matrix AP 208V-240V, 60Hz	6
Table 3-3: Watt Loss - Matrix AP 380V-415V, 50Hz	7
Table 3-4: Watt Loss - Matrix AP 480V, 60Hz	8
Table 3-5: Watt Loss - Matrix AP 600V, 60Hz	9
Table 3-6: Watt Loss - Matrix AP 690V, 50Hz	10
Table 3-7: Typical Performance with Unbalanced Line Voltage	12
Table 4-1: Matrix AP 208V-240V Open Panel	17
Table 4-2: Matrix AP 208V-240V Enclosed	18
Table 4-3: Matrix AP 380V-415V Open Panel	19
Table 4-4: Matrix AP 380V-415V Enclosed	20
Table 4-5: Matrix AP 480V Open Panel	21
Table 4-6: Matrix AP 480V Enclosed	22
Table 4-7: Matrix AP 600V Open Panel	23
Table 4-8: Matrix AP 600V Enclosed	24
Table 4-9: Matrix AP 690V Open Panel	25
Table 5-1: Overtemperature Switch	27
Table 5-2: Contactor Coil Switching Currents	37
Table 5-3: Torque Ratings – 208V-240V	38
Table 5-4: Torque Ratings – 380V-415V	39
Table 5-5: Torque Ratings – 480V	40
Table 5-6: Torque Ratings – 600V	41
Table 5-7: Torque Ratings – 690V	42
Table 7-1: Troubleshooting Guide	47



1. SAFETY

Warnings and Cautions

The following symbols are used in this manual:

 WARNING	High Voltage Warning: warns of situations that dangerously high voltage is involved. Failure to use proper precautions may lead to serious injury or death.
 WARNING	General Warning: warns of situations that can result in serious injury or death if proper precautions are not used.
 Caution	General Caution: identifies situations that could lead to malfunction or possible equipment damage.

General Safety Instructions

 WARNING	<p>High Voltage! Only a qualified electrician can carry out the electrical installation of this filter.</p>
	<p>High voltage is used in the operation of this filter. Use extreme caution to avoid contact with high voltage when operating, installing or repairing this filter. Injury or death may result if safety precautions are not observed.</p>
 WARNING	<p>The opening of the branch circuit protective device may be an indication that a fault current has been interrupted. To reduce the risk of fire or electrical shock, current-carrying parts and other components of the filter should be examined and replaced if damaged.</p>
	<p>An upstream disconnect/protection device must be used as required by the National Electrical Code (NEC) or governing authority.</p>
	<p>Even if the upstream disconnect/protection device is open, the drive downstream of the filter may feedback high voltage to the filter. The drive safety instructions must be followed. Injury or death may result if safety precautions are not observed.</p>
	<p>The filter must be grounded with a grounding conductor connected to all grounding terminals. Open panel filters must have reactor grounded through a 2"x2" area cleaned of paint and varnish on lower mounting bracket.</p>
	<p>Only spare parts obtained from MTE Corporation or an authorized MTE distributor can be used.</p>
	<p>After removing power, allow at least five minutes to elapse and verify that the capacitors have discharged to a safe level before contacting internal components. Connect a DC voltmeter across the capacitor terminals and ensure that the voltage is at a safe level.</p>
 Caution	<p>Loose or improperly secured connections may damage or degrade filter performance. Visually inspect and secure all electrical connections before power is applied to the filter.</p>
	<p>The user of this filter must assure that the input voltage and frequency is correct for the filter rating and that the voltage applied falls within the rated operating tolerance envelop specified for the filter. For sever power line applications where the power feed is likely to experience surges and transients that exceed the input voltage rating, it is recommended that a TVSS (Transient Voltage Surge Suppression) or SPD (Surge Protection Device) be deployed ahead of the filter to reduce the possibility of exceeding the filter rated voltage. Consult with TVSS or SPD manufacturer to determine the correct protection requirements for your power line conditions.</p>

2. GENERAL INFORMATION

The purpose of the manual is to properly specify, size, and install the Matrix AP.

For the most current Matrix AP information, please refer to our website:

www.mtecorp.com/products/matrix-ap-harmonic-filters/

This manual is intended for use by personnel experienced in the operation and maintenance of drives. Because of the high voltages required by the filter, drive and the potential dangers presented by rotating machinery, it is essential that all personnel involved in the operation and maintenance of this filter know and practice the necessary safety precautions for this type of equipment. Personnel should read and understand the instructions contained in this manual before installing, operating or servicing the filter and drive to which it is connected.

Receipt & Repair Statement

Upon Receipt of this Filter:

The Matrix AP harmonic filter has been subjected to demanding factory tests before shipment. Carefully inspect the shipping container for damage that may have occurred in transit. Then unpack the filter and carefully inspect for any signs of damage. Save the shipping container for future transport of the filter.

In the event of damage, please contact and file a claim with the freight carrier involved immediately.

If the equipment is not going to be put into service upon receipt, cover and store the filter in a clean, dry location. After storage, ensure that the equipment is dry and that no condensation or dirt has accumulated on the internal components of the filter before applying power.

Repair/Exchange Procedure

MTE Corporation requires a Return Material Authorization Number and form before we can accept any filters that qualify for return or repair. If problems or questions arise during installation, setup, or operation of the filter, please contact MTE for assistance at:

Toll Free: 1-800-455-4MTE (1-800-455-4683)

International Tel: (+1)-262-253-8200

Fax: (+1)-262-253-8222

Enclosures

MTE enclosures are designed to provide a degree of protection for electrical components and prevent incidental personnel contact with the enclosed equipment. Depending on the enclosure selected, these enclosures meet the requirements of NEMA 1, 2 or 3R.

An approximate cross reference guide between NEMA, UL, CSA and IEC enclosure follows.

Type 1 NEMA / IEC IP20 Enclosure:

Are designed for indoor use and will provide protection against contact with the enclosed equipment.

Type 2 NEMA / IEC IP20 Enclosure:

Are designed for indoor use and will provide protection against contact with the enclosed equipment and provide a degree of protection against limited amounts of falling water and dirt.

Type 3R NEMA / IEC IP23 Enclosure:

Are designed for outdoor use primarily to provide protection against contact with the enclosed equipment and provide a degree of protection against falling rain sleet and external ice formation.

Agency Approvals

UL and cUL listed to UL508 Type Mx and CSA-C22.2 No 14-95
File E180243

Warranty

Three years from the date of shipment. See <https://www.mtecorp.com/industry-leading-warranty/> for details.

3. MATRIX AP PERFORMANCE DATA

Performance Specifications

Table 3-1: Performance Specifications

Service Conditions	Load: 6-pulse variable torque rectifier only
Input Voltage(s)	208V Version (PN#'s MAPxxxxxA) - 208-240 VAC +/- 10%. 60 + 0.75 Hz. 3 phase 400V Version (PN#'s MAPxxxxxC) - 380-415 VAC +/- 10%. 50 + 0.75 Hz. 3 phase 480V Version (PN#'s MAPxxxxxD) - 480 VAC +/- 10%, 60 + 0.75 Hz. 3 phase 600V Version (PN#'s MAPxxxxxE) - 600 VAC +/- 10%. 60 + 0.75 Hz. 3 phase 690V Version (PN#'s MAPxxxxxF) - 690 VAC +/- 10%. 50 + 0.75 Hz. 3 phase
Input voltage line unbalance	1% maximum to ensure performance guaranty
Maximum source impedance	6.00% to ensure performance guaranty. Please contact MTE for sizing with Gensets.
Minimum source impedance	1.5%
Service Factor	1.00
Overload	150% for 1-minute duration with 10% output voltage reduction of nominal of voltage
Ambient Temperature (Operating)	Refer to Figure 3-5: Temperature Derating for derating guidelines
Insulation System	Class N (200 degrees C)
Enclosed Filters	320A and above: -40 to +45 degrees C with no derating Below 320A: -40 to +40 degrees C with no derating
Open Panel Filters	-40 to +50 degrees C with no derating
Storage Temperature	-40 to +90 degrees C
Altitude	0 to 3300 Feet above sea level. Refer to Figure 3-4: Altitude Derating Curve for altitude de-rating
Relative Humidity	0 to 95% non-condensing
Over Voltage	Category II
Insertion Loss	+5% no load -5% full load

Generator sizing note: Generator sizing is best completed by sizing programs or help from a generator manufacturing representative. Identify every load type and size that will be powered from the generator. If non-linear loads are present the generator may need to be oversized.

Generator rated KVA minimum load \geq Matrix rated current $\times \sqrt{3}$ generator voltage

FLA load current \leq Matrix filter rated current

Notes (SCCR):

The Short Circuit Current Rating (SCCR) is not required under Exception No.1 of UL508A SB4.2.1 effective 4/25/06. This exception also applies to all the Contactor Options (002, 009, 012, and similar), where the Contactors are separated from the Main Power path by exempt components (such as Reactors) of sufficient Impedance, which is assured in case of the Reactors that are integral components of our Filter.



Filter Efficiency + Watt loss Matrix AP 208V-240V, 60Hz

Table 3-2: Watt Loss - Matrix AP 208V-240V, 60Hz

Maximum Output (Amps RMS)	Efficiency (%)	Typical Power Dissipation @ Rated Current (Watts)	Typical Capacitor Current (Amps RMS)
6	97.3%	95	2.0
8	97.4%	102	2.6
11	97.6%	122	3.6
14	98.4%	180	4.6
21	98.6%	187	6.9
27	98.5%	191	8.9
34	98.4%	217	11.2
44	97.9%	269	14.5
52	97.7%	287	17.2
66	98.1%	334	21.8
83	98.2%	373	27.4
103	99.2%	475	34.0
128	98.6%	558	42.2
165	98.9%	601	54.5
208	99.1%	681	68.6
240	99.0%	1093	79.2
320	98.9%	1305	105.6
403	98.7%	1636	133

NOTE: Use the IEC AC-3 rating for the corresponding filter capacitor current when selecting a contactor.

Filter Efficiency + Watt loss Matrix AP 380V-415V, 50Hz

Table 3-3: Watt Loss - Matrix AP 380V-415V, 50Hz

Maximum Output (Amps RMS)	Efficiency (%)	Typical Power Dissipation @ Rated Current (Watts)	Typical Capacitor Current (Amps RMS)
6	97.5%	114	2.2
8	97.6%	149	3.5
11	97.9%	180	4.8
14	98.1%	206	5.4
21	98.6%	235	7.5
27	98.7%	266	10.2
34	98.8%	298	13.2
44	98.9%	356	15.9
52	99.0%	388	19.3
66	99.1%	459	24.9
83	99.1%	565	31.2
103	99.2%	660	38.1
128	99.0%	973	43.9
165	99.2%	1,030	55.0
208	99.2%	1,263	72.7
240	99.2%	1,423	80.6
320	99.4%	1,450	104.7
403	99.4%	1,816	138.8
482	99.5%	2,008	157.6
636	99.5%	2,359	218.6
786	99.6%	2,604	271.9
850	99.6%	2,974	299.3
1000	99.5%	3,954	341.1
1200	99.6%	4,136	420.0

NOTE: Use the IEC AC-3 rating for the corresponding filter capacitor current when selecting a contactor.

Filter Efficiency + Watt loss Matrix AP 480V, 60Hz

Table 3-4: Watt Loss - Matrix AP 480V, 60Hz

Maximum Output (Amps RMS)	Efficiency (%)	Typical Power Dissipation @ Rated Current (Watts)	Typical Capacitor Current (Amps RMS)
6	97.5%	122	1.9
8	97.6%	158	2.6
11	97.9%	192	3.7
14	98.1%	220	4.6
21	98.6%	251	6.9
27	98.7%	283	9.2
34	98.8%	318	11.8
44	98.9%	379	14.5
52	99.0%	413	17.2
66	99.1%	488	22.2
83	99.1%	600	29.2
103	99.2%	702	34.7
128	99.0%	1,035	39.8
165	99.2%	1,096	53.2
208	99.2%	1,343	64.8
240	99.2%	1,514	72.7
320	99.4%	1,543	94.5
403	99.4%	1,932	132.3
482	99.5%	2,137	141.8
636	99.5%	2,509	195.6
786	99.6%	2,771	245.0
850	99.6%	3,163	265.9
1000	99.5%	4,206	308.6
1200	99.6%	4,400	355.2
1600	99.4%	4,500	496.5
2000	99.4%	5,050	696.5
2300	99.4%	6,100	716.0

NOTE: Use the IEC AC-3 rating for the corresponding filter capacitor current when selecting a contactor.

Filter Efficiency + Watt loss Matrix AP 600V, 60Hz

Table 3-5: Watt Loss - Matrix AP 600V, 60Hz

Maximum Output (Amps RMS)	Efficiency (%)	Typical Power Dissipation @ Rated Current (Watts)	Typical Capacitor Current (Amps RMS)
6	97.6%	150	1.9
8	97.8%	183	2.6
11	98.2%	205	3.7
14	98.3%	250	4.6
21	98.7%	285	6.9
27	98.9%	304	9.2
34	99.0%	366	11.8
44	99.1%	395	14.5
52	99.1%	494	17.2
66	99.0%	655	22.2
83	99.1%	718	29.2
103	99.0%	1085	34.7
128	99.2%	1090	39.8
165	99.3%	1285	53.2
208	99.3%	1431	64.8
240	99.3%	1624	72.7
320	99.4%	2021	94.5
403	99.5%	2208	132.3
482	99.5%	2481	141.8
636	99.6%	2884	195.6
786	99.6%	3368	245.0

NOTE: Use the IEC AC-3 rating for the corresponding filter capacitor current when selecting a contactor.



Filter Efficiency + Watt loss Matrix AP 690V, 50Hz

Table 3-6: Watt Loss - Matrix AP 690V, 50Hz

Maximum Output (Amps RMS)	Efficiency (%)	Typical Power Dissipation @ Rated Current (Watts)	Typical Capacitor Current (Amps RMS)
52	98.9%	681	17.2
66	98.9%	844	21.8
83	99.1%	850	27.4
103	99.1%	1051	33.9
128	99.3%	1106	42.2
165	99.4%	1257	54.5
208	99.4%	1400	68.6
240	99.4%	1721	79.2
320	99.5%	2031	105.6
403	99.4%	2780	132.9
482	99.5%	2883	159.1
636	99.6%	3140	209.9

NOTE: Use the IEC AC-3 rating for the corresponding filter capacitor current when selecting a contactor.

Load Effect on THID

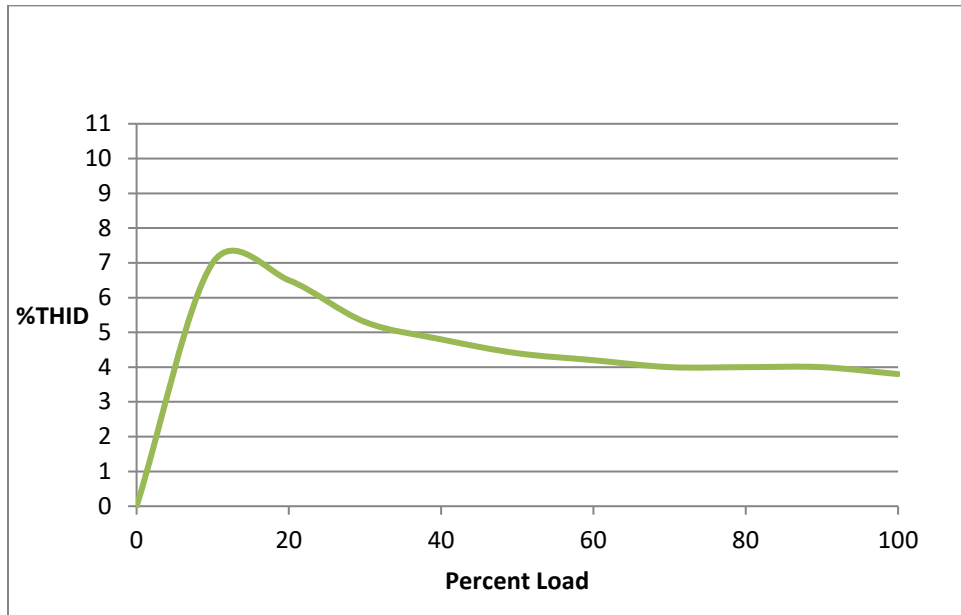

Figure 3-1: Load Effect on THID

Typical Harmonic Spectrum

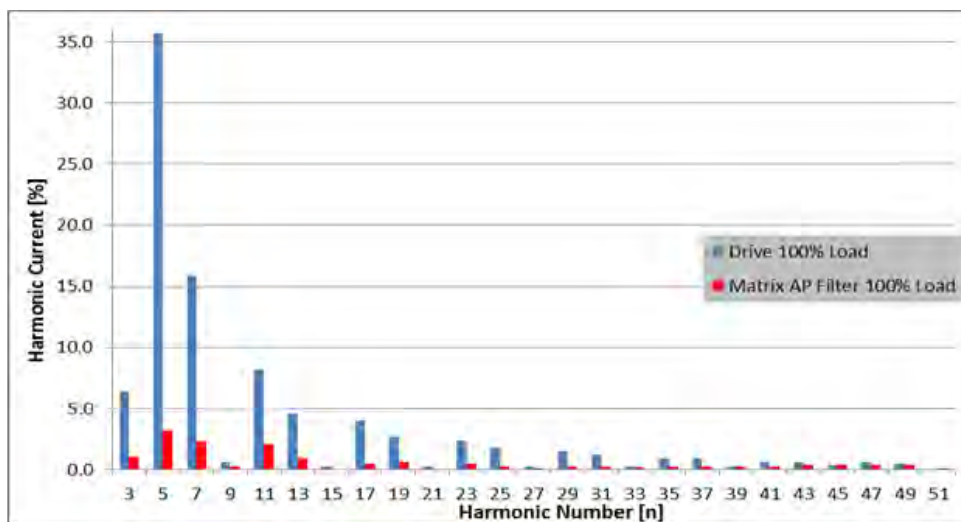

Figure 3-2: Typical Harmonic Spectrum with and without Matrix AP

Power Factor

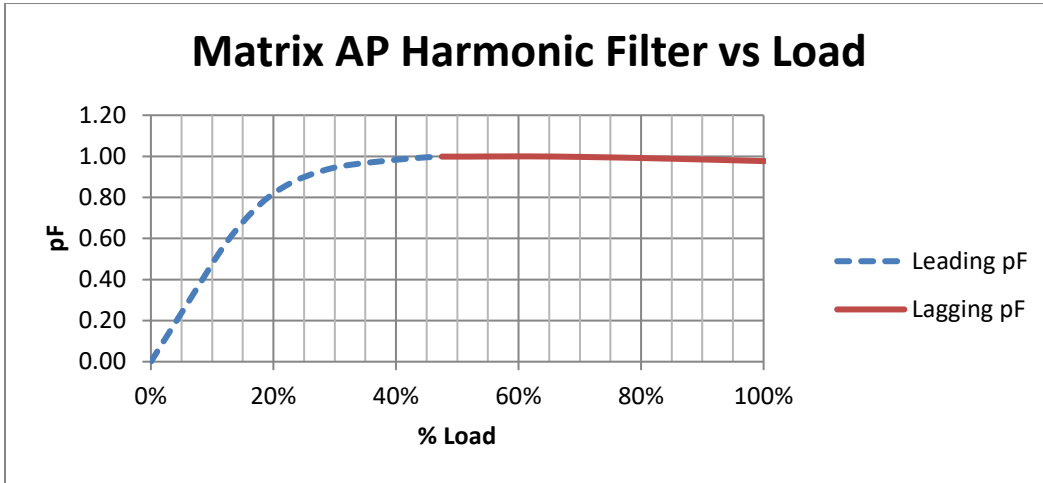

Figure 3-3: Power Factor

Typical Performance with Unbalanced Line Voltage

Table 3-7: Typical Performance with Unbalanced Line Voltage

All Components at Nominal Values and Worse Case Service Conditions	
100% Load	
Nominal THID	4.2%
1% Unbalance	4.4%
2% Unbalance	4.8%
3% Unbalance	5.4%
30% Load	
Nominal THID	7.0%
1% Unbalance	7.3%
2% Unbalance	7.9%
3% Unbalance	8.8%

Altitude Derating

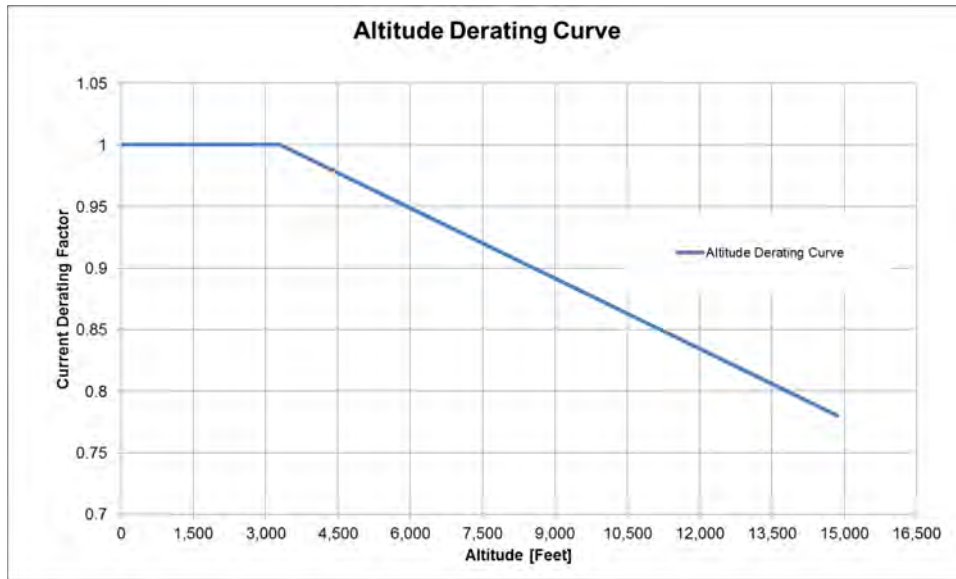

Figure 3-4: Altitude Derating Curve

Temperature Derating

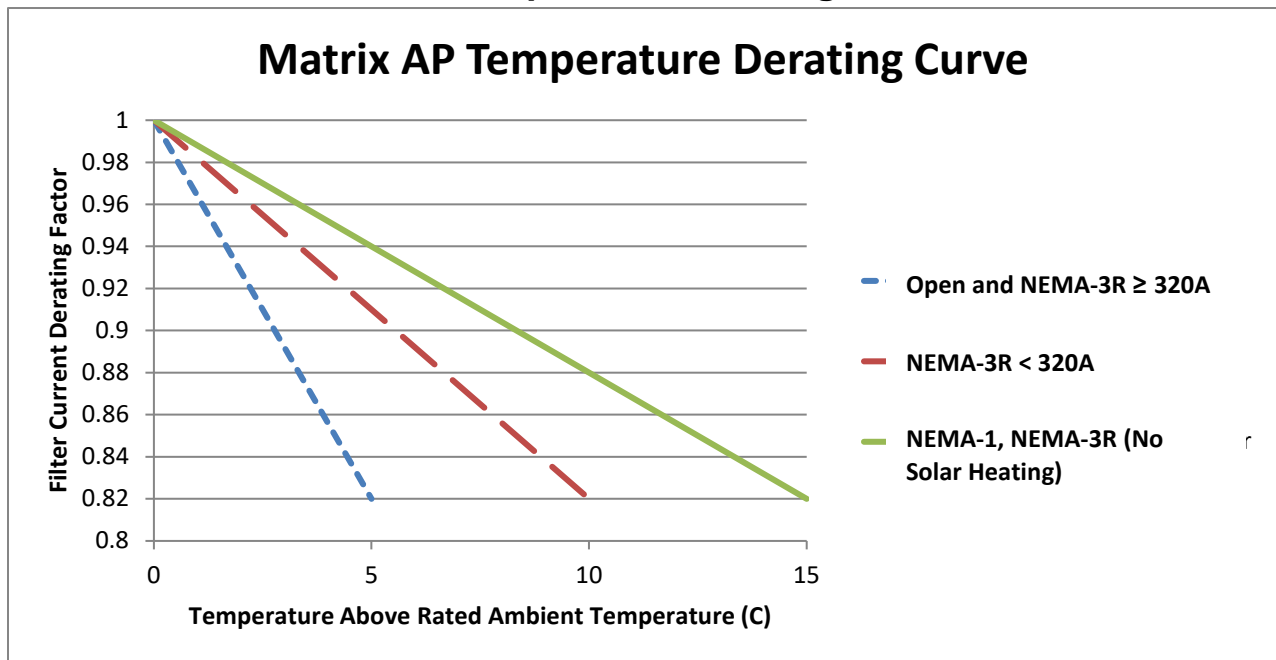

Figure 3-5: Temperature Derating

NOTE: Do not extend derating beyond published data.
See or click [Table 3-1: Performance Specifications \(p5\)](#) for temperature ratings

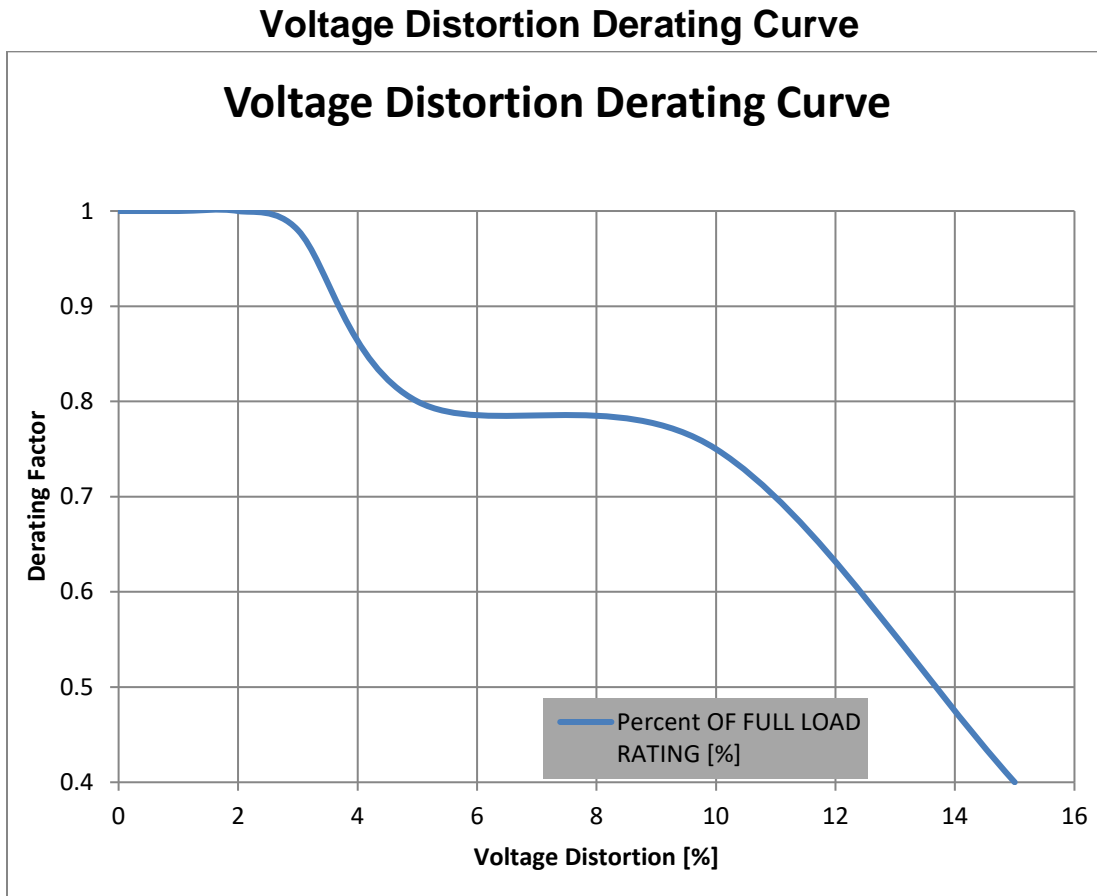

Figure 3-6: Voltage Distortion Derating Curve

NOTE: This plot assists in proper derating of a Matrix AP harmonic filter in environments with a given voltage distortion. Example: In a system with 10% voltage distortion, a Matrix filter will need to be oversized by 25% to obtain the same performance as an appropriate filter in a 0% distortion environment.

4. HOW TO SELECT

Selection Guide

The MTE Corporation Matrix AP harmonic filter is designed for harmonic mitigation of 6-pulse inverter drives supplying variable torque loads in a wide variety of applications. The suitability of this filter for a specific application must therefore be determined by the customer. In no event will MTE Corporation assume responsibility or liability for any direct or consequential damages resulting from the use or application of this filter, nor will MTE Corporation assume patent liability with respect to the use of information, circuits or equipment described in this instruction manual. The Matrix AP harmonic filter uses a patented Adaptive Passive Harmonic Mitigating Reactor (AP HMR) technology to limit full load current distortion to less than 5% THID and 8% THID at 30% load.

Matrix AP harmonic filters are available in Open Panel, NEMA 1/2, and NEMA 3R mechanical configurations.

NOTE: For inverters feeding isolation transformers select a filter with a current rating equal to or greater than that of the transformer primary current.

Please verify information below for proper selection:

- Line Voltage and Frequency:** Input voltage from 240V – 690V at standard frequency. See Table 3-1: Performance Specifications (p5) for specification.
- Current Rating:** 208V-240V 6-403 Amp, 380V-415V 6-1200 Amp, 480V 6-2300 Amp, 600V 6-786 Amp, 690V 52-636 Amp.
- Voltage Distortion:** See Figure 3-6: Voltage Distortion Derating Curve (p14) for voltage distortion derating curve.
- Contactor Option:** See Figure 5-4: Contactor Option – 002 (p33) for contactor option 002, Figure 5-5: Contactor Option – 009 (p34) for contactor option 009, Figure 5-6: Contactor Option – 012 (p35) for contactor option 012, and Figure 5-7: Contactor Option – 013 (p36) for contactor option 013.
- Performance:** See Table 3-1: Performance Specifications (p5) for specification.
- Temperature:** See Table 3-1: Performance Specifications (p5) for specification, and Figure 3-5: Temperature Derating (p13) for temperature derating.
- Altitude:** 3,300 feet above sea level without derating. See Figure 3-4: Altitude Derating Curve (p13) for derating curve.
- Enclosure Type:** Open Panel, NEMA 1/2 & NEMA 3R, see (p4) for enclosure descriptions.
- Refer to Article 430 Table 430.91 of the National Electrical code for the selection of the appropriate enclosure Type Number for your application.



Understanding the MATRIX AP Part Number:

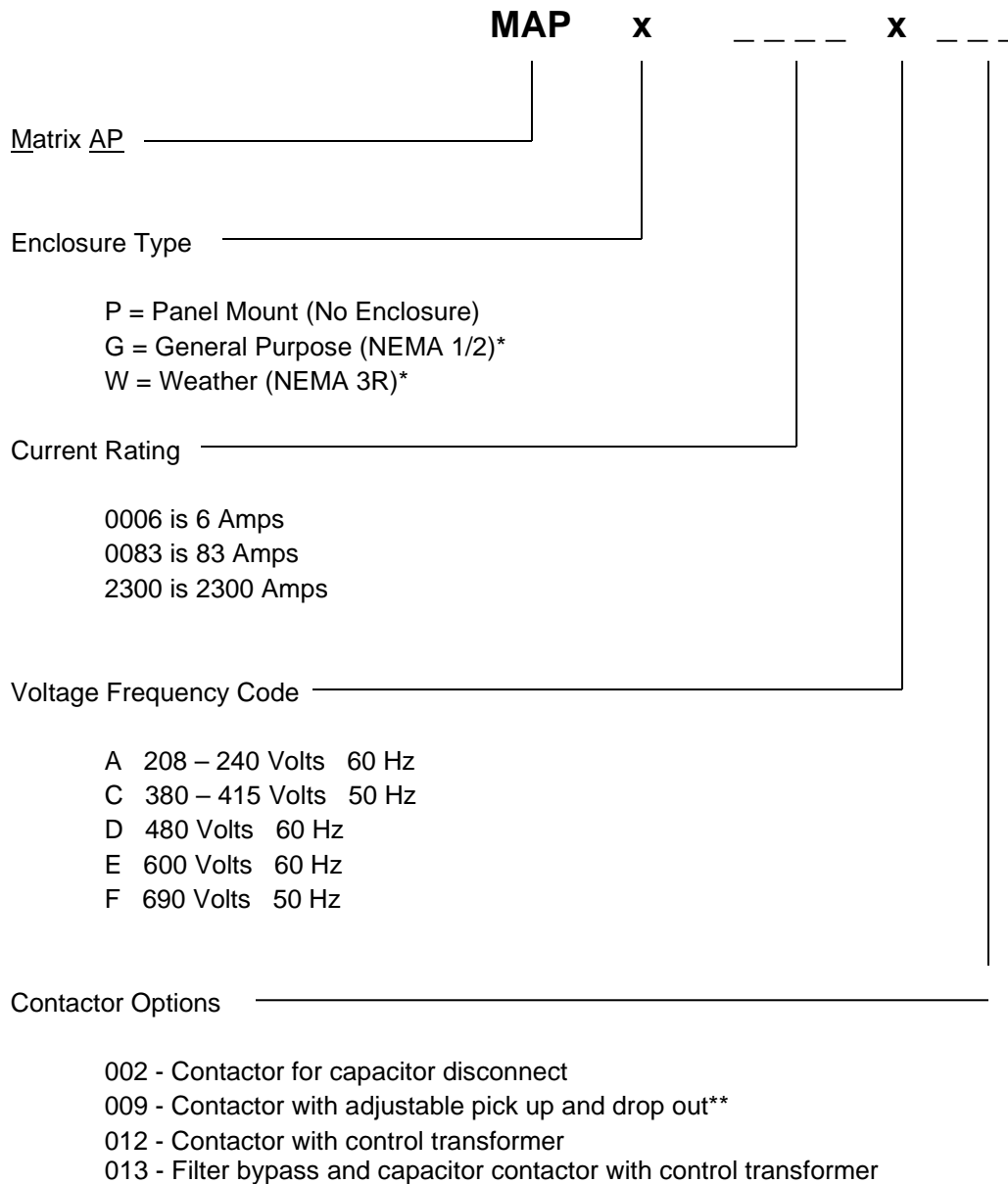

Additional Options

Option - 400

Standard NEMA 3R enclosure with optional rodent/serpent screen

Option 400 provides intake exhaust air screens with (¼ x ¼) mesh

*Not available on units 1600A (480V) and above

**Contact MTE for support if an adjustment is needed

Matrix AP 208-240 Volts, 60Hz Selection Tables Open Panel

Table 4-1: Matrix AP 208V-240V Open Panel

Motor HP	Filter Amps Rating	Part Number	App. Wt. (lbs.)	Open Magnetics (in.) (H x W x D)	Capacitor (in.) (H x W) Capacitor Panel (in.) (H x W x D)
1.5	6	MAPP0006A	19	8.5 x 8.0 x 5.4	7.5 x 3.0
2	8	MAPP0008A	19	8.5 x 8.0 x 5.4	7.5 x 3.0
3	11	MAPP0011A	22	8.6 x 8.0 x 5.4	7.5 x 4.6
5	14	MAPP0014A	21	8.6 x 8.0 x 5.4	7.5 x 3.9
5	21	MAPP0021A	30	9.8 X 8.0 X 4.8	9.1 x 4.6
7.5	27	MAPP0027A	36	9.7 x 9.0 x 5.3	9.1 x 4.6
10	34	MAPP0034A	51	11.7 x 10.5 x 6.7	10.6 x 4.6
15	44	MAPP0044A	52	11.6 x 10.5 x 7.2	9.0 x 4.6
20	52	MAPP0052A	56	11.7 x 10.5 x 7.2	9.0 x 3.5
25	66	MAPP0066A	64	11.6 x 10.5 x 7.7	9.0 x 3.9
30	83	MAPP0083A	77	11.6 x 10.5 x 9.1	9.0 x 3.9
40	103	MAPP0103A	111	14.0 x 12.0 x 9.6	10.6 x 4.6 10.6 x 4.6
50	128	MAPP0128A	134	14.0 x 12.0 x 10.8	10.6 x 4.6 10.6 x 4.6
60	165	MAPP0165A	157	13.9 x 13.4 x 12.0	10.6 x 4.6 9.0 x 4.6
75	208	MAPP0208A	174	14.0 x 13.4 x 12.0	9.0 x 4.6 9.0 x 4.6
100	240	MAPP0240A	225	19.9 x 15.3 x 11.9	6.7 x 7.6 x 16.4
125	320	MAPP0320A	263	19.9 x 15.3 x 12.8	6.7 x 7.6 x 16.4
150	403	MAPP0403A	280	20.0 x 15.3 x 12.8	8.3 x 7.6 x 16.4

NOTE: Approximate weight of filter above includes weight of reactor and accompanying capacitor and/or cap-panel assembly.

NOTE: Reference drawings can be accessed by clicking on part number.



Matrix AP 208-240 Volts, 60Hz Selection Tables Enclosed

Table 4-2: Matrix AP 208V-240V Enclosed

Motor KW	Filter Amps Rating	Part Number	NEMA 1/2 Enclosure (in.) (H x W x D)	App. Weight (lbs.)	Part Number	NEMA 3R Enclosure (in.) (H x W x D)	App. Weight (lbs.)
1.5	6	MAPG0006A	24.0 x 12.5 x 17.9	65	MAPW0006A	24.0 x 12.5 x 23.0	73
2	8	MAPG0008A	24.0 x 12.5 x 17.9	65	MAPW0008A	24.0 x 12.5 x 23.0	73
3	11	MAPG0011A	24.0 x 12.5 x 17.9	69	MAPW0011A	24.0 x 12.5 x 23.0	77
5	14	MAPG0014A	24.0 x 12.5 x 17.9	68	MAPW0014A	24.0 x 12.5 x 23.0	76
5	21	MAPG0021A	24.0 x 12.5 x 17.9	77	MAPW0021A	24.0 x 12.5 x 23.0	85
7.5	27	MAPG0027A	24.0 x 12.5 x 17.9	84	MAPW0027A	24.0 x 12.5 x 23.0	92
10	34	MAPG0034A	24.0 x 12.5 x 17.9	98	MAPW0034A	24.0 x 12.5 x 23.0	105
15	44	MAPG0044A	24.0 x 12.5 x 17.9	100	MAPW0044A	24.0 x 12.5 x 23.0	108
20	52	MAPG0052A	24.0 x 12.5 x 17.9	105	MAPW0052A	24.0 x 12.5 x 23.0	109
25	66	MAPG0066A	24.0 x 12.5 x 17.9	112	MAPW0066A	24.0 x 12.5 x 23.0	120
30	83	MAPG0083A	24.0 x 12.5 x 17.9	124	MAPW0083A	24.0 x 12.5 x 23.0	132
40	103	MAPG0103A	33.9 x 18.3 x 20.9	185	MAPW0103A	33.9 x 18.3 x 26.0	195
50	128	MAPG0128A	33.9 x 18.3 x 20.9	207	MAPW0128A	33.9 x 18.3 x 26.0	218
60	165	MAPG0165A	33.9 x 18.3 x 20.9	232	MAPW0165A	33.9 x 18.3 x 26.0	243
75	208	MAPG0208A	33.9 x 18.3 x 20.9	249	MAPW0208A	33.9 x 18.3 x 26.0	259
100	240	MAPG0240A	51.3 x 27.7 x 24.9	394	MAPW0240A	51.3 x 27.7 x 30.0	407
125	320	MAPG0320A	51.3 x 27.7 x 24.9	432	MAPW0320A	51.3 x 27.7 x 30.0	445
150	403	MAPG0403A	51.3 x 27.7 x 24.9	448	MAPW0403A	51.3 x 27.7 x 30.0	461

NOTE: Reference drawings can be accessed by clicking on part number.

Matrix AP 380-415 Volts, 50Hz Selection Tables Open Panel

Table 4-3: Matrix AP 380V-415V Open Panel

Motor KW	Filter Amps Rating	Part Number	App. Wt. (lbs.)	Open Magnetics (in.) (H x W x D)	Capacitor (in.) (H x W) Capacitor Panel (in.) (H x W x D)
1.1-2.2	6	MAPP0006C	20	8.6 x 8.0 x 5.4	7.5 x 3.0
-	8	MAPP0008C	21	8.7 x 8.0 x 5.4	7.5 x 3.0
3.7	11	MAPP0011C	28	9.9 x 9.0 x 4.8	7.5 x 3.0
5.5	14	MAPP0014C	34	9.8 x 9.0 x 5.3	8.0 x 3.9
7.5	21	MAPP0021C	51	11.7 x 10.5 x 6.7	8.0 x 3.9
11	27	MAPP0027C	58	11.8 x 10.5 x 7.2	8.3 x 4.6
15	34	MAPP0034C	69	11.7 x 10.5 x 7.7	9.2 x 4.6
18.5-22	44	MAPP0044C	81	11.7 x 10.5 x 8.2	9.2 x 4.6
-	52	MAPP0052C	104	14.0 x 12.0 x 9.0	9.2 x 4.6
30	66	MAPP0066C	117	14.0 x 12.0 x 9.0	10.6 x 4.6
37-45	83	MAPP0083C	138	14.0 x 12.0 x 10.9	10.6 x 4.6
55	103	MAPP0103C	151	14.1 x 12.0 x 11.0	10.6 x 4.6
-	128	MAPP0128C	218	20.0 x 15.3 x 10.7	11.1 x 16.4 x 7.6
75-90	165	MAPP0165C	274	20.0 x 15.3 x 11.7	8.0 x 16.4 x 7.6
110	208	MAPP0208C	291	20.1 x 15.3 x 11.8	9.9 x 16.4 x 7.6
-	240	MAPP0240C	324	19.9 x 15.3 x 12.8	11.1 x 16.4 x 7.6
150	320	MAPP0320C	421	20.0 x 15.3 x 17.8	9.9 x 16.4 x 7.6
185-220	403	MAPP0403C	433	23.2 x 15.3 x 13.7	11.1 x 16.4 x 7.6
-	482	MAPP0482C	541	23.3 x 15.3 x 14.8	(2) 8.0 x 16.4 x 7.6
280	636	MAPP0636C	683	25.8 x 24.0 x 16.5	(2) 9.9 x 16.4 x 7.6
375	786	MAPP0786C	781	25.7 x 24.0 x 17.9	(2) 11.1 x 16.4 x 7.6
450	850	MAPP0850C	978	25.9 x 24.0 x 20.3	(2) 9.9 x 16.4 x 7.6 8.0 x 16.4 x 7.6
525	1000	MAPP1000C	970	25.9 x 24.0 x 21.2	(3) 9.9 x 16.4 x 7.6
600	1200	MAPP1200C	999	26.0 x 24.0 x 22.2	(3) 11.1 x 16.4 x 7.6

NOTE: Approximate weight of filter above includes weight of reactor and accompanying capacitor and/or cap-panel assembly.

NOTE: Reference drawings can be accessed by clicking on part number.



Matrix AP 380-415 Volts, 50Hz Selection Tables Enclosed

Table 4-4: Matrix AP 380V-415V Enclosed

Motor KW	Filter Amps Rating	Part Number	NEMA 1/2 Enclosure (in.) (H x W x D)	App. Weight (lbs.)	Part Number	NEMA 3R Enclosure (in.) (H x W x D)	App. Weight (lbs.)
1.1-2.2	6	MAPG0006C	24.0 x 12.5 x 17.9	67	MAPW0006C	24.0 x 12.5 x 23.0	74
-	8	MAPG0008C	24.0 x 12.5 x 17.9	68	MAPW0008C	24.0 x 12.5 x 23.0	76
3.7	11	MAPG0011C	24.0 x 12.5 x 17.9	75	MAPW0011C	24.0 x 12.5 x 23.0	83
5.5	14	MAPG0014C	24.0 x 12.5 x 17.9	82	MAPW0014C	24.0 x 12.5 x 23.0	89
7.5	21	MAPG0021C	24.0 x 12.5 x 17.9	99	MAPW0021C	24.0 x 12.5 x 23.0	106
11	27	MAPG0027C	24.0 x 12.5 x 17.9	105	MAPW0027C	24.0 x 12.5 x 23.0	113
15	34	MAPG0034C	24.0 x 12.5 x 17.9	117	MAPW0034C	24.0 x 12.5 x 23.0	124
18.5-22	44	MAPG0044C	24.0 x 12.5 x 17.9	128	MAPW0044C	24.0 x 12.5 x 23.0	136
-	52	MAPG0052C	33.9 x 18.3 x 20.9	179	MAPW0052C	33.9 x 18.3 x 26.0	189
30	66	MAPG0066C	33.9 x 18.3 x 20.9	192	MAPW0066C	33.9 x 18.3 x 26.0	202
37-45	83	MAPG0083C	33.9 x 18.3 x 20.9	225	MAPW0083C	33.9 x 18.3 x 26.0	224
55	103	MAPG0103C	33.9 x 18.3 x 20.9	226	MAPW0103C	33.9 x 18.3 x 26.0	237
-	128	MAPG0128C	51.3 x 27.7 x 24.9	386	MAPW0128C	51.3 x 27.7 x 30.0	399
75-90	165	MAPG0165C	51.3 x 27.7 x 24.9	443	MAPW0165C	51.3 x 27.7 x 30.0	456
110	208	MAPG0208C	51.3 x 27.7 x 24.9	460	MAPW0208C	51.3 x 27.7 x 30.0	473
-	240	MAPG0240C	51.3 x 27.7 x 24.9	493	MAPW0240C	51.3 x 27.7 x 30.0	506
150	320	MAPG0320C	76.0 x 27.7 x 24.9	658	MAPW0320C	76.0 x 27.7 x 34.0	683
185-220	403	MAPG0403C	76.0 x 27.7 x 24.9	660	MAPW0403C	76.0 x 27.7 x 34.0	687
-	482	MAPG0482C	87.6 x 43.7 x 31.1	952	MAPW0482C	87.6 x 43.7 x 40.1	997
280	636	MAPG0636C	87.6 x 43.7 x 31.1	1091	MAPW0636C	87.6 x 43.7 x 40.1	1138
375	786	MAPG0786C	87.6 x 43.7 x 31.1	1187	MAPW0786C	87.6 x 43.7 x 40.1	1232
450	850	MAPG0850C	84.0 x 52.0 x 36.5	1600	MAPW0850C	84.0 x 52.0 x 45.5	1641
525	1000	MAPG1000C	84.0 x 52.0 x 36.5	1576	MAPW1000C	84.0 x 52.0 x 45.5	1617
600	1200	MAPG1200C	84.0 x 52.0 x 36.5	1602	MAPW1200C	84.0 x 52.0 x 45.5	1643

NOTE: Reference drawings can be accessed by clicking on part number.

Matrix AP 480 Volts, 60Hz Selection Tables Open Panel

Table 4-5: Matrix AP 480V Open Panel

Motor HP	Filter Amps Rating	Part Number	App. Wt. (lbs.)	Open Magnetics (in.) (H x W x D)	Capacitor (in.) (H x W) Capacitor Panel (in.) (H x W x D)
3	6	MAPP0006D	20	8.7 x 8.0 x 5.4	7.5 x 3.0
5	8	MAPP0008D	21	8.7 x 8.0 x 5.4	7.5 x 3.0
7.5	11	MAPP0011D	28	9.9 x 9.0 x 4.8	7.5 x 3.0
10	14	MAPP0014D	32	9.8 x 9.0 x 5.3	7.5 x 3.0
15	21	MAPP0021D	51	11.7 x 10.5 x 6.6	8.0 x 3.9
20	27	MAPP0027D	56	11.8 x 10.5 x 7.2	8.0 x 3.9
25	34	MAPP0034D	67	11.7 x 10.5 x 7.7	8.0 x 3.9
30	44	MAPP0044D	80	11.7 x 10.5 x 8.2	8.3 x 4.6
40	52	MAPP0052D	103	14.0 x 12.0 x 9.1	9.2 x 4.6
50	66	MAPP0066D	116	14.0 x 12.0 x 9.0	9.2 x 4.6
60	83	MAPP0083D	139	14.0 x 12.0 x 10.9	10.6 x 4.6
75	103	MAPP0103D	151	14.1 x 12.0 x 11.0	10.6 x 4.6
100	128	MAPP0128D	204	20.0 x 15.3 x 10.7	6.7 x 16.4 x 7.6
125	165	MAPP0165D	233	20.0 x 15.3 x 11.8	6.7 x 16.4 x 7.6
150	208	MAPP0208D	286	20.1 x 15.3 x 11.8	6.7 x 16.4 x 7.6
200	240	MAPP0240D	323	20.0 x 15.3 x 12.7	6.7 x 16.4 x 7.6
250	320	MAPP0320D	418	20.0 x 15.3 x 14.8	8.0 x 16.4 x 7.6
300	403	MAPP0403D	418	23.3 x 15.3 x 13.7	9.9 x 16.4 x 7.6
400	482	MAPP0482D	533	23.3 x 15.3 x 14.8	(2) 6.7 x 16.4 x 7.6
500	636	MAPP0636D	667	25.8 x 24.0 x 16.5	(2) 8.0 x 16.4 x 7.6
600	786	MAPP0786D	774	25.7 x 24.0 x 17.9	(2) 9.9 x 16.4 x 7.6
700	850	MAPP0850D	967	25.9 x 24.0 x 20.3	(2) 6.7 x 16.4 x 7.6 8.0 x 16.4 x 7.6
900	1000	MAPP1000D	945	25.9 x 24.0 x 21.2	(2) 8.0 x 16.4 x 7.6 9.9 x 16.4 x 7.6
1000	1200	MAPP1200D	980	26.0 x 24.0 x 22.2	(3) 9.9 x 16.4 x 7.6
1300	1600	MAPP1600D	2272	33.4 x 36.0 x 29.3	(4) 9.9 x 16.4 x 7.6
1500	2000	MAPP2000D	2678	33.6 x 36.0 x 31.3	(5) 9.9 x 16.4 x 7.6
1850	2300	MAPP2300D	2893	33.4 x 36.0 x 32.4	(6) 9.9 x 16.4 x 7.6

NOTE: Approximate weight of filter above includes weight of reactor and accompanying capacitor and/or cap-panel assembly.

NOTE: Reference drawings can be accessed by clicking on part number.



Matrix AP 480 Volts, 60Hz Selection Tables Enclosed

Table 4-6: Matrix AP 480V Enclosed

Motor HP	Filter Amps Rating	Part Number	NEMA 1/2 Enclosure (in.) (H x W x D)	App. Weight (lbs.)	Part Number	NEMA 3R Enclosure (in.) (H x W x D)	App. Weight (lbs.)
3	6	MAPG0006D	24.0 x 12.5 x 17.9	67	MAPW0006D	24.0 x 12.5 x 23.0	75
5	8	MAPG0008D	24.0 x 12.5 x 17.9	68	MAPW0008D	24.0 x 12.5 x 23.0	76
7.5	11	MAPG0011D	24.0 x 12.5 x 17.9	75	MAPW0011D	24.0 x 12.5 x 23.0	83
10	14	MAPG0014D	24.0 x 12.5 x 17.9	80	MAPW0014D	24.0 x 12.5 x 23.0	88
15	21	MAPG0021D	24.0 x 12.5 x 17.9	99	MAPW0021D	24.0 x 12.5 x 23.0	106
20	27	MAPG0027D	24.0 x 12.5 x 17.9	104	MAPW0027D	24.0 x 12.5 x 23.0	112
25	34	MAPG0034D	24.0 x 12.5 x 17.9	114	MAPW0034D	24.0 x 12.5 x 23.0	122
30	44	MAPG0044D	24.0 x 12.5 x 17.9	128	MAPW0044D	24.0 x 12.5 x 23.0	135
40	52	MAPG0052D	33.9 x 18.3 x 20.9	177	MAPW0052D	33.9 x 18.3 x 26.0	188
50	66	MAPG0066D	33.9 x 18.3 x 20.9	190	MAPW0066D	33.9 x 18.3 x 26.0	201
60	83	MAPG0083D	33.9 x 18.3 x 20.9	212	MAPW0083D	33.9 x 18.3 x 26.0	219
75	103	MAPG0103D	33.9 x 18.3 x 20.9	226	MAPW0103D	33.9 x 18.3 x 26.0	237
100	128	MAPG0128D	51.3 x 27.7 x 24.9	370	MAPW0128D	51.3 x 27.7 x 30.0	383
125	165	MAPG0165D	51.3 x 27.7 x 24.9	437	MAPW0165D	51.3 x 27.7 x 30.0	450
150	208	MAPG0208D	51.3 x 27.7 x 24.9	452	MAPW0208D	51.3 x 27.7 x 30.0	464
200	240	MAPG0240D	51.3 x 27.7 x 24.9	488	MAPW0240D	51.3 x 27.7 x 30.0	501
250	320	MAPG0320D	76.0 x 27.7 x 24.9	655	MAPW0320D	76.0 x 27.7 x 34.0	680
300	403	MAPG0403D	76.0 x 27.7 x 24.9	655	MAPW0403D	76.0 x 27.7 x 34.0	680
400	482	MAPG0482D	87.6 x 43.7 x 31.1	944	MAPW0482D	87.6 x 43.7 x 40.1	989
500	636	MAPG0636D	87.6 x 43.7 x 31.1	1084	MAPW0636D	87.6 x 43.7 x 40.1	1129
600	786	MAPG0786D	87.6 x 43.7 x 31.1	1180	MAPW0786D	87.6 x 43.7 x 40.1	1225
700	850	MAPG0850D	84.0 x 52.0 x 36.5	1589	MAPW0850D	84.0 x 52.0 x 45.5	1630
900	1000	MAPG1000D	84.0 x 52.0 x 36.5	1565	MAPW1000D	84.0 x 52.0 x 45.5	1606
1000	1200	MAPG1200D	84.0 x 52.0 x 36.5	1593	MAPW1200D	84.0 x 52.0 x 45.5	1635

NOTE: Reference drawings can be accessed by clicking on part number.

Matrix AP 600 Volts, 60Hz Selection Tables Open Panel

Table 4-7: Matrix AP 600V Open Panel

Motor HP	Filter Amps Rating	Part Number	App. Wt. (lbs.)	Open Magnetics (in.) (H x W x D)	Capacitor (in.) (H x D) Capacitor Panel (in.) (H x W x D)
5	6	MAPP0006E	20	8.7 x 8.0 x 5.4	7.5 x 3.0
5	8	MAPP0008E	28	9.8 x 9.0 x 4.8	7.5 x 3.0
10	11	MAPP0011E	43	9.8 x 9.0 x 5.3	7.5 x 3.0
10	14	MAPP0014E	60	11.7 x 10.5 x 6.7	9.2 x 4.6
15	21	MAPP0021E	60	11.7 x 10.5 x 7.2	7.5 x 3.9
25	27	MAPP0027E	69	11.7 x 10.5 x 7.7	8.3 x 4.6
30	34	MAPP0034E	89	11.7 x 10.5 x 8.2	8.3 x 4.6
40	44	MAPP0044E	137	14.0 x 12.0 x 9.9	9.2 x 4.6
50	52	MAPP0052E	140	14.1 x 12.0 x 10.3	9.2 x 4.6
60	66	MAPP0066E	166	14.0 x 12.0 x 11.0	10.6 x 4.6
75	83	MAPP0083E	148	14.1 x 12.0 x 10.9	10.6 x 4.6
100	103	MAPP0103E	205	20.0 x 15.3 x 10.7	6.7 x 16.4 x 7.6
125	128	MAPP0128E	269	20.0 x 15.3 x 11.7	6.7 x 16.4 x 7.6
150	165	MAPP0165E	287	20.1 x 15.3 x 11.9	6.7 x 16.4 x 7.6
200	208	MAPP0208E	328	20.1 x 15.3 x 12.8	7.7 x 16.4 x 7.6
250	240	MAPP0240E	427	19.9 x 15.3 x 15.8	7.7 x 16.4 x 7.6
300	320	MAPP0320E	500	23.3 x 15.3 x 15.8	9.2 x 16.4 x 7.6
400	403	MAPP0403E	510	23.3 x 15.3 x 16.1	12.1 x 16.4 x 7.6
500	482	MAPP0482E	670	25.9 x 24.0 x 16.6	(2) 7.7 x 16.4 x 7.6
600	636	MAPP0636E	754	25.9 x 24.0 x 17.7	(2) 9.2 x 16.4 x 7.6
800	786	MAPP0786E	931	26.0 x 24.0 x 19.5	(2) 12.1 x 16.4 x 7.6

NOTE: Approximate weight of filter above includes weight of reactor and accompanying capacitor and/or cap-panel assembly.

NOTE: Reference drawings can be accessed by clicking on part number.



Matrix AP 600 Volts, 60Hz Selection Tables Enclosed

Table 4-8: Matrix AP 600V Enclosed

Motor HP	Filter Amps Rating	Part Number	NEMA 1/2 Enclosure (in.) (H x W x D)	App. Weight (lbs.)	Part Number	NEMA 3R Enclosure (in.) (H x W x D)	App. Weight (lbs.)
5	6	MAPG0006E	24.0 x 12.5 x 17.9	68	MAPW0006E	24.0 x 12.5 x 23.0	75
5	8	MAPG0008E	24.0 x 12.5 x 17.9	75	MAPW0008E	24.0 x 12.5 x 23.0	83
10	11	MAPG0011E	24.0 x 12.5 x 17.9	79	MAPW0011E	24.0 x 12.5 x 23.0	88
10	14	MAPG0014E	24.0 x 12.5 x 17.9	95	MAPW0014E	24.0 x 12.5 x 23.0	102
15	21	MAPG0021E	24.0 x 12.5 x 17.9	107	MAPW0021E	24.0 x 12.5 x 23.0	115
25	27	MAPG0027E	24.0 x 12.5 x 17.9	117	MAPW0027E	24.0 x 12.5 x 23.0	125
30	34	MAPG0034E	24.0 x 12.5 x 17.9	126	MAPW0034E	24.0 x 12.5 x 23.0	133
40	44	MAPG0044E	33.9 x 18.3 x 20.9	198	MAPW0044E	33.9 x 18.3 x 26.0	209
50	52	MAPG0052E	33.9 x 18.3 x 20.9	202	MAPW0052E	33.9 x 18.3 x 26.0	213
60	66	MAPG0066E	33.9 x 18.3 x 20.9	241	MAPW0066E	33.9 x 18.3 x 26.0	252
75	83	MAPG0083E	33.9 x 18.3 x 20.9	224	MAPW0083E	33.9 x 18.3 x 26.0	235
100	103	MAPG0103E	51.3 x 27.7 x 24.9	371	MAPW0103E	51.3 x 27.7 x 30.0	384
125	128	MAPG0128E	51.3 x 27.7 x 24.9	436	MAPW0128E	51.3 x 27.7 x 30.0	449
150	165	MAPG0165E	51.3 x 27.7 x 24.9	455	MAPW0165E	51.3 x 27.7 x 30.0	468
200	208	MAPG0208E	51.3 x 27.7 x 24.9	488	MAPW0208E	51.3 x 27.7 x 30.0	494
250	240	MAPG0240E	76.0 x 27.7 x 24.9	661	MAPW0240E	76.0 x 27.7 x 34.0	687
300	320	MAPG0320E	76.0 x 27.7 x 24.9	738	MAPW0320E	76.0 x 27.7 x 34.0	764
400	403	MAPG0403E	87.6 x 43.7 x 31.1	914	MAPW0403E	87.6 x 43.7 x 40.1	959
500	482	MAPG0482E	87.6 x 43.7 x 31.1	1091	MAPW0482E	87.6 x 43.7 x 40.1	1136
600	636	MAPG0636E	87.6 x 43.7 x 31.1	1230	MAPW0636E	87.6 x 43.7 x 40.1	1275
800	786	MAPG0786E	84.0 x 52.0 x 36.5	1535	MAPW0786E	84.0 x 52.0 x 45.5	1576

NOTE: Reference drawings can be accessed by clicking on part number.

Matrix AP 690 Volts, 50Hz Selection Tables Open Panel

Table 4-9: Matrix AP 690V Open Panel



Motor KW	Filter Amps Rating	Part Number	App. Wt. (lbs.)	Open Magnetics (in.) (H x W x D)	Capacitor (in.) (H x D) Capacitor Panel (in.) (H x W x D)
37	52	MAPP0052F	191	19.8 x 15.3 x 11.1	6.7 x 16.4 x 7.6
45	66	MAPP0066F	207	19.8 x 15.3 x 11.2	7.7 x 16.4 x 7.6
55	83	MAPP0083F	254	19.8 x 15.3 x 11.6	6.7 x 16.4 x 7.6
75	103	MAPP0103F	242	20.1 x 15.3 x 11.7	9.2 x 16.4 x 7.6
90	128	MAPP0128F	324	19.9 x 15.3 x 12.7	8.0 x 16.4 x 7.6
110	165	MAPP0165F	408	19.9 x 15.3 x 14.8	10.7 x 16.3 x 7.6
150	208	MAPP0208F	449	23.1 x 15.3 x 13.7	6.7 x 16.4 x 7.6 7.7 x 16.4 x 7.6
185	240	MAPP0240F	504	23.2 x 15.3 x 14.9	7.7 x 16.4 x 7.6 8.0 x 16.4 x 7.6
222	320	MAPP0320F	672	25.9 x 24.0 x 16.7	(2) 9.9 x 16.4 x 7.6
280	403	MAPP0403F	982	25.8 x 24.0 x 17.8	6.7 x 16.4 x 7.6 (2) 9.9 x 16.4 x 7.6
375	482	MAPP0482F	1167	25.9 x 24.0 x 19.0	(3) 9.9 x 16.4 x 7.6
450	636	MAPP0636F	1089	25.9 x 24.0 x 21.6	11.1 x 16.4 x 7.6 (2) 11.1 x 16.4 x 7.6

NOTE: Approximate weight of filter above includes weight of reactor and accompanying capacitor and/or cap-panel assembly.

NOTE: Reference drawings can be accessed by clicking on part number.

5. HOW TO INSTALL

Installation Checklist

 WARNING	Prior to installation, please refer to all general warnings on pages 1 & 2. Failure to practice this can result in body injury!
	Input and output wiring to the filter should be performed by authorized personnel in accordance with NEC and all local electrical codes and regulations.
 WARNING	The filter is designed for use with copper conductors with a minimum temperature rating of 75 degrees C.
	Do not install capacitor assembly above/near the Harmonic Mitigating Reactor. Premature or catastrophic failure may occur.

Matrix AP filters are supplied in the following mechanical configurations:

- Open Panel Mount: Open panel units consist of a reactor and one or more capacitor panel modules referred to as cap-panels on drawings and diagrams. Additional wiring between the reactor and capacitor/capacitor panel is required by customer.
- Floor mounted general purpose NEMA 1/2, & NEMA 3R cabinets: Reactor and capacitor/capacitor assemblies are supplied in a cabinet with all items pre-wired together.

Minimum Required Space:

Open panel filters are designed for mounting in the customer’s enclosure. Include the power dissipation of the filter along with all the other components located in the panel to determine the internal temperature rise and cooling requirements of the enclosure. A general guideline is to allow a side clearance of four (4) inches and a vertical clearance of six (6) inches for proper heat dissipation and access within the enclosure. Clearances may be less if proper ventilation exists. Filter components must operate within temperatures specified in this manual or filter operating life will be compromised. Also, be aware of minimum electrical clearances as defined by the appropriate system safety standard(s). Open panel Matrix AP filters generate heat and should be positioned away from heat sensitive components. Ensure that proper panel orientation is maintained. Avoid locations where the filter would be subjected to excessive vibrations. Locate the filter as close to the drive as possible.

NOTE: Locate the capacitor panel in the lowest temperature regions of the enclosure – generally toward the bottom and away from high temperature components.

General purpose NEMA 1/2, and NEMA 3R enclosed filters are designed for floor mounting in an environment suitable for the enclosure type. Do not install in or near a corrosive environment. Allow a minimum side and back clearance of eight (8) inches and front clearance of thirty-six (36) inches for proper heat dissipation and access. For lower ambient temperatures and increased air flow clearance distances can be reduced.

Grounding

 WARNING	The filter must always be grounded with a grounding conductor connected to ground terminals.
	For open panel units, ensure a 2" x 2" area is cleaned of paint and varnish on lower mounting bracket for ground connection.

NOTE: For cable shield grounding follow the drive manufacturer’s recommendations.

Grounding and Ground Fault Protection

The filter must always be grounded with a grounding conductor connected to all ground terminals.

Due to high leakage currents associated with variable frequency drives, ground fault protective devices do not necessarily operate correctly when placed ahead of a Matrix Filter feeding a drive. When using this type of device, its function should be tested in the actual installation.

Overtemperature Interlock

An overtemperature interlock circuit should be used in conjunction with thermal switch to turn off the drive to prevent filter damage due to abnormal operating conditions. The temperature switch is normally closed and will open when an internal reactor temperature of 180°C is reached. See Table 5-1: Overtemperature Switch below for contact rating information and the drive user manual for interconnection information.

Table 5-1: Overtemperature Switch

<i>NC Switch</i> opens at 180 Deg. +/- 5 Deg. C		
Current Amps	Voltage	Contact Load
6	120 AC	Resistive Loads
3	120 AC	Inductive Loads
3	240 AC	Resistive Loads
2.5	240 AC	Inductive Loads
8	12 VDC	Resistive Loads
4	24 VDC	Resistive Loads

MTE highly recommends the use of the overtemperature switch to prevent damage to the filter in rare instances of overheating from abnormal operating conditions.

Power Wiring Connection

 WARNING	Input and output power wiring to the filter should be performed by authorized personnel in accordance with the NEC and all local electrical codes and regulations. Cable lugs and mounting hardware are provided by the customer.
	Any extremely low or high resistance readings indicate a mis-wire and may result in damage to filter components if not corrected.
	On NEMA 3R enclosures, CAB-26AP and larger, no live parts shall be mounted below 8 inches from the bottom of the enclosure.

Verify that the power source to which the filter is to be connected is in agreement with the nameplate data on the filter. A fused disconnect switch or circuit breaker should be installed between the filter and its source of power in accordance with the requirements of the NEC and all local electrical codes and regulations. Refer to the drive user manual for selection of the correct fuse rating and class.

- For panel mounted filter applications, interconnection between the filter, its power source, the cap-panels, and the drive is shown in Figure 5-2: Open Panel Interconnection (p31).
- For filters supplied in general purpose NEMA 1/2 & NEMA 3R cabinets, interconnection between the filter, its power source, and the drive is shown in Figure 5-3: Enclosed Interconnection (p32).

Wire gauge range and terminal torque requirements as well as selecting conductors that interconnect the HMR and capacitor assemblies are shown in:

- Table 5-3: Torque Ratings – 208V-240V (p38)
- Table 5-4: Torque Ratings – 380V-415V (p39)
- Table 5-5: Torque Ratings – 480V (p40)
- Table 5-6: Torque Ratings – 600V (p41)
- Table 5-7: Torque Ratings – 690V (p42)

Filters that use multiple cap-panels share total cap current are shown in:

- Table 3-2: Watt Loss - Matrix AP 208V-240V, 60Hz (p6)
- Table 3-3: Watt Loss - Matrix AP 380V-415V, 50Hz (p7)
- Table 3-4: Watt Loss - Matrix AP 480V, 60Hz (p8)
- Table 3-5: Watt Loss - Matrix AP 600V, 60Hz (p9)
- Table 3-6: Watt Loss - Matrix AP 690V, 50Hz (p10)

Refer to the drive user manual for instructions on interconnecting the drive and motor and the correct start-up procedures for the drive.

The filter is designed for use with copper conductors with a minimum temperature rating of 75 degrees C.

Wiring Checks

Using Figure 5-1: Basic Schematic Diagram (p30) and Figure 5-3: Enclosed Interconnection (p32), visually check the wired components to confirm, verify, and correct wiring. Then, with a multi meter, check phase to phase isolation using the 100 K ohm range. The multi meter will read the parallel equivalent of the bleeder resistors after the capacitors initially charge. All phase to phase resistance values should be the same.

Check for the Following Faults:

- Capacitor shorted
- Capacitor bus not connected
- Capacitor bus to chassis short
- Paralleling wiring errors

Basic Schematic Diagram

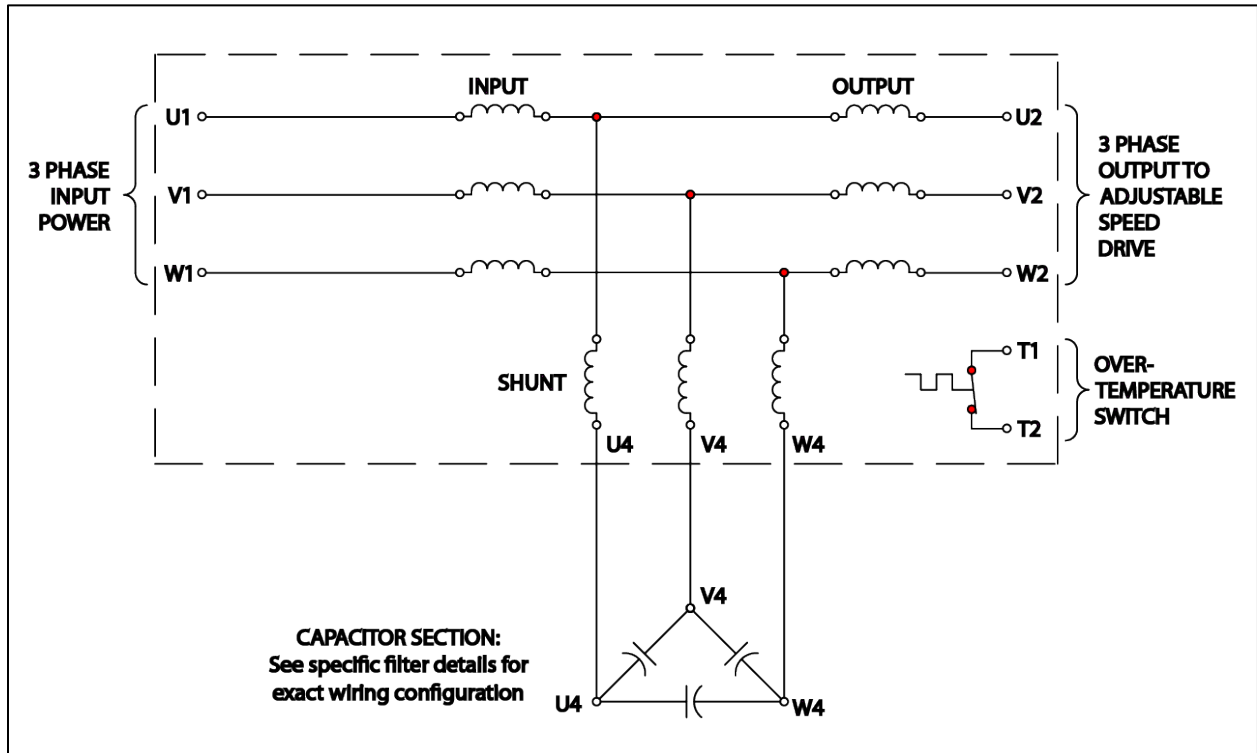

Figure 5-1: Basic Schematic Diagram

NOTE: Drawing depicts delta configuration for capacitors, 690V filters are connected in a WYE configuration.

Open Panel Unit Interconnection Diagram

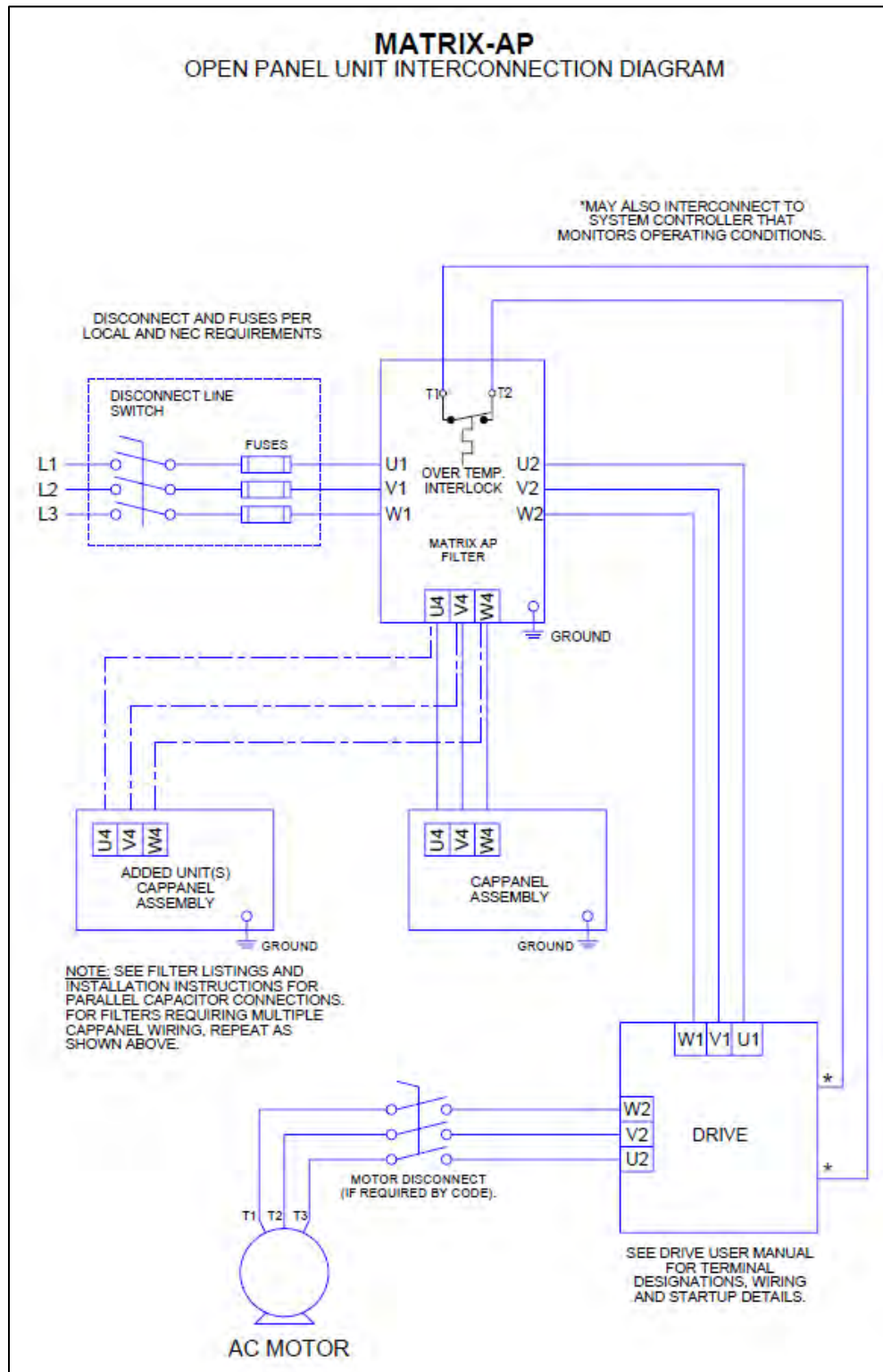

Figure 5-2: Open Panel Interconnection

Enclosed Unit Interconnection Diagram

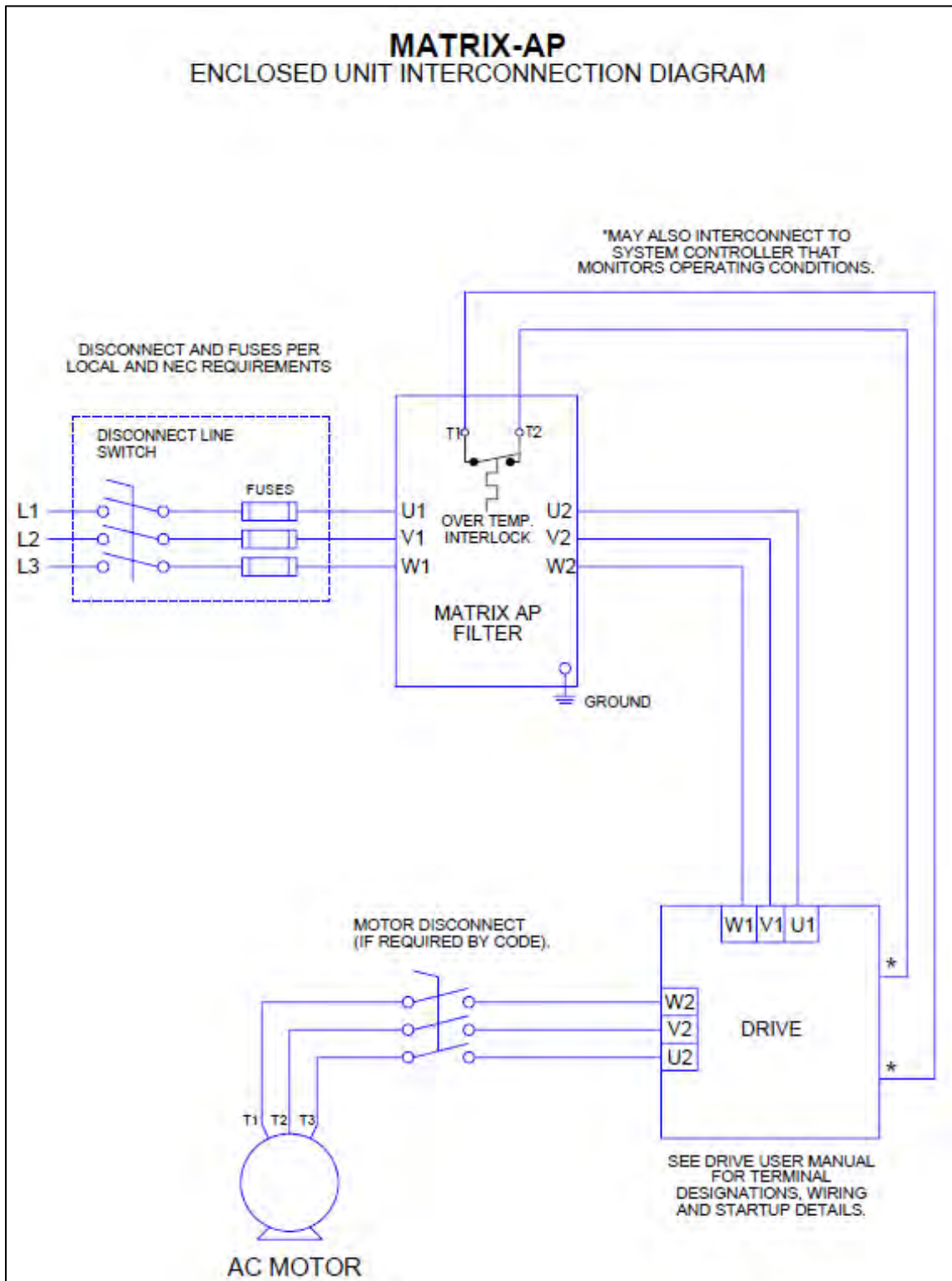

Figure 5-3: Enclosed Interconnection

Contactor Option

Option – 002

Capacitor contactor

This option provides a contactor to disconnect the filter capacitor bank when the drive is not running. The contactor is supplied with NO/NC auxiliary contacts. The contactor coil and auxiliary contacts are wired to a customer terminal block. This option is provided pre-wired complete for enclosed filters and as loose parts for open panel filters.

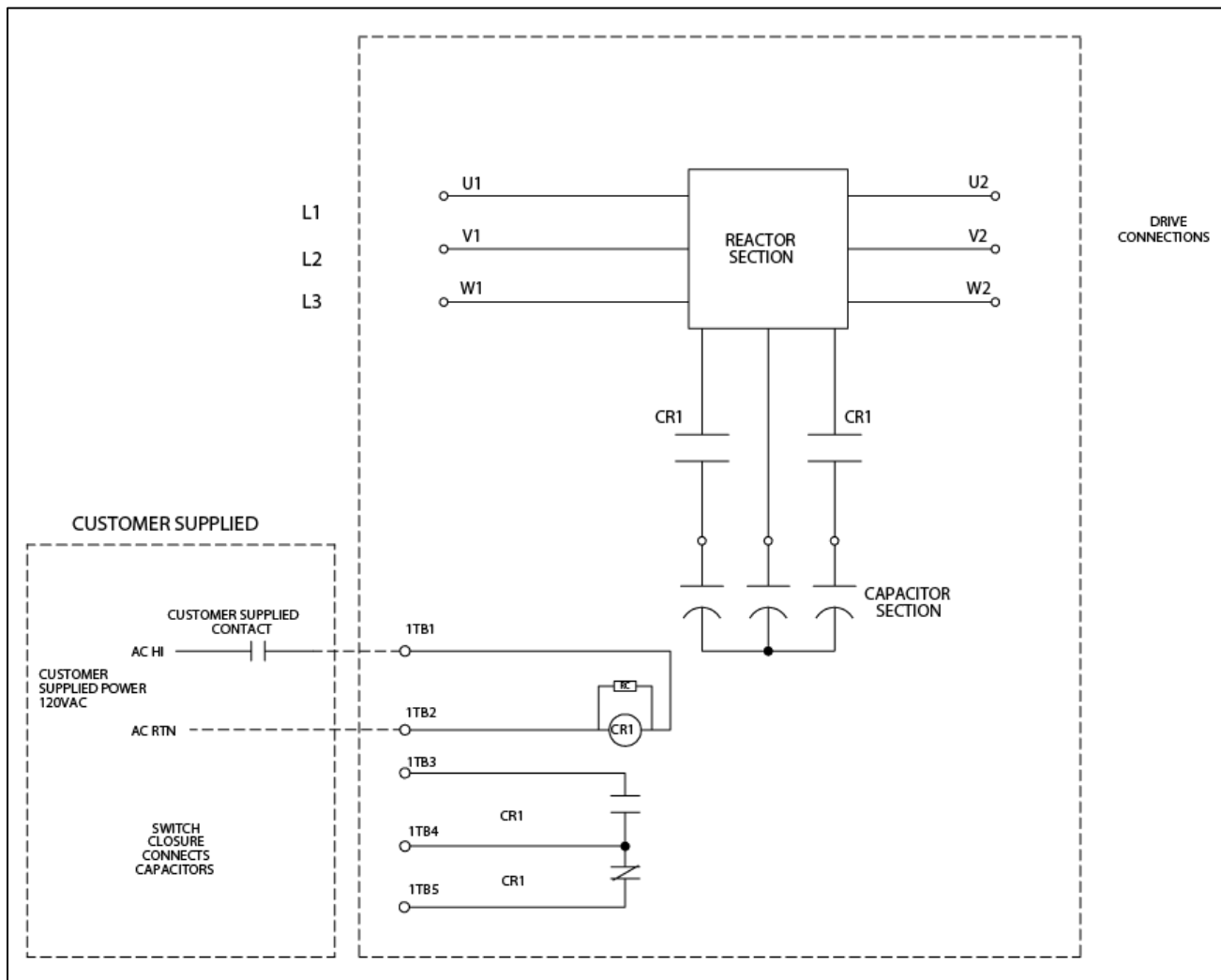

Figure 5-4: Contactor Option – 002

NOTE: The above contactor option diagram is provided to help understand the circuit function and does not reflect actual circuit wiring.

Option – 009

Capacitor contactor with adjustable pick up and drop out

This option provides a contactor to disconnect the filter capacitor bank based on the motor load current. Two current operated switches provide independent adjustment of the pick-up and drop out current levels. The switches are preset at the factory for pick up at 35% and drop out at 20% of the filter output current rating. This option is only available for enclosed filters.

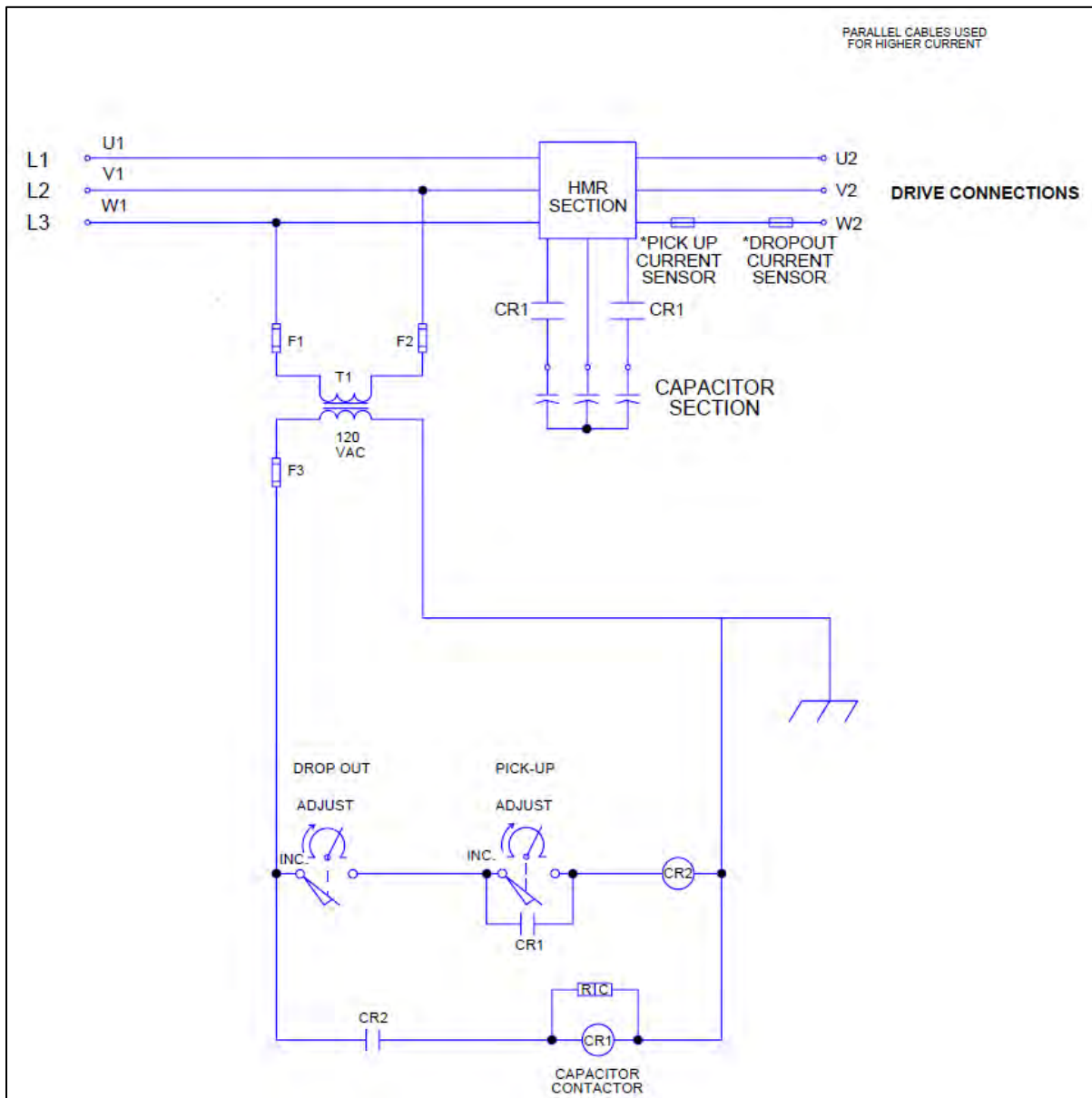

Figure 5-5: Contactor Option – 009

NOTE: The above contactor option diagram is provided to help understand the circuit function and does not reflect actual circuit wiring.

Option – 012

Capacitor contactor with control transformer

This option provides a control transformer to power the capacitor contactor. The contactor is provided with NO/NC auxiliary contacts. For filter ratings 165 amps and above a pilot relay is also provided to limit inrush current below 0.60 amps. Connections are wired to a customer terminal block. This option is only available for enclosed filters.

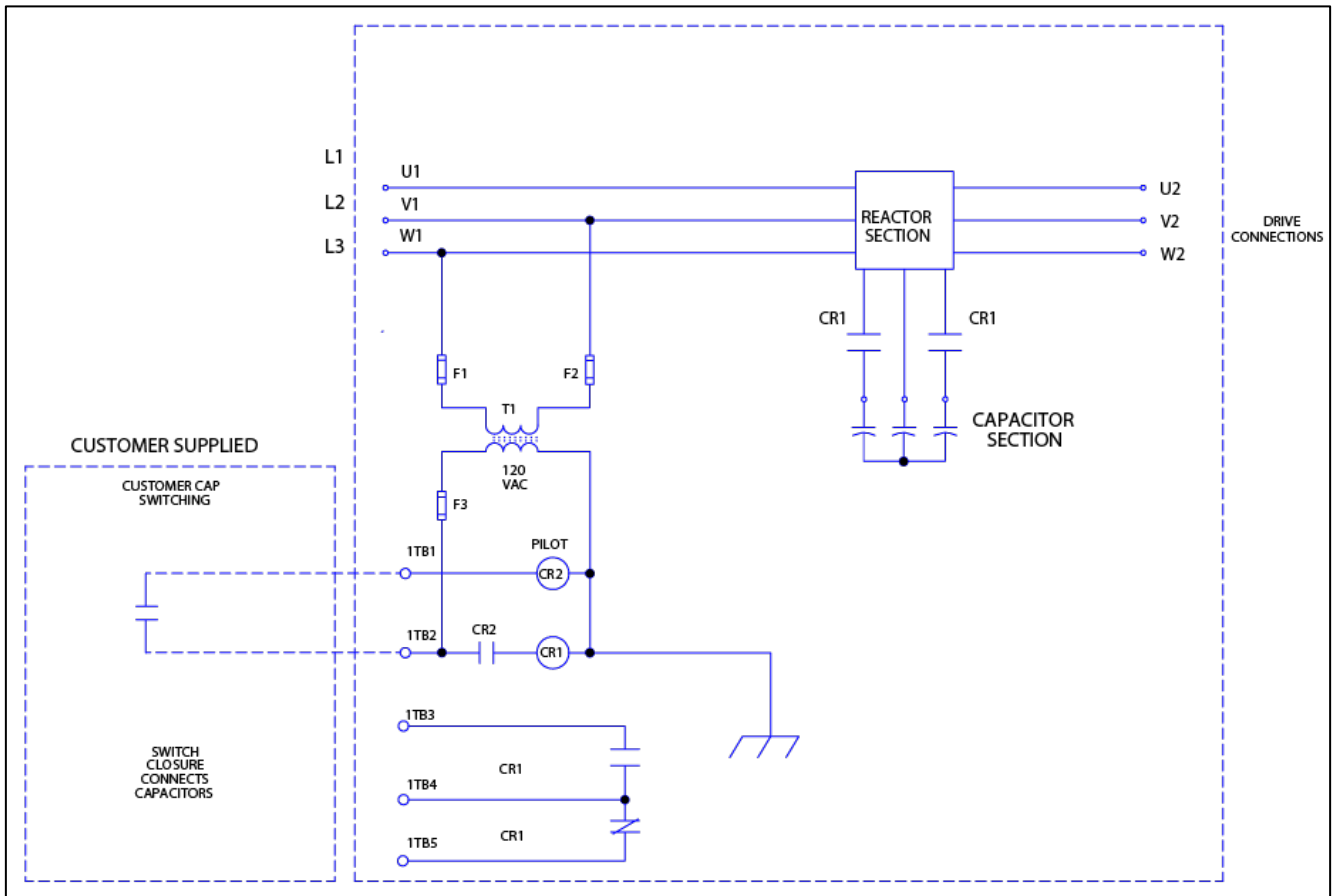

Figure 5-6: Contactor Option – 012

NOTE: The above contactor option diagram is provided to help understand the circuit function and does not reflect actual circuit wiring.

Option – 013

Filter bypass and capacitor contactor with control transformer

This option provides a 120 VAC control transformer to power the capacitor and bypass contactors. Contactors are provided with NO/NC auxiliary contacts. For filter ratings 44 amps and above pilot relays are also provided to limit inrush currents below 0.60 amps. A jumper selection provides single contact switching for normal bypass control with capacitor removal. Connections are wired to a customer terminal block. To incorporate this option for a selected filter current rating use the part numbers shown below and select the option list price from the table below. This option is only available for enclosed filters.

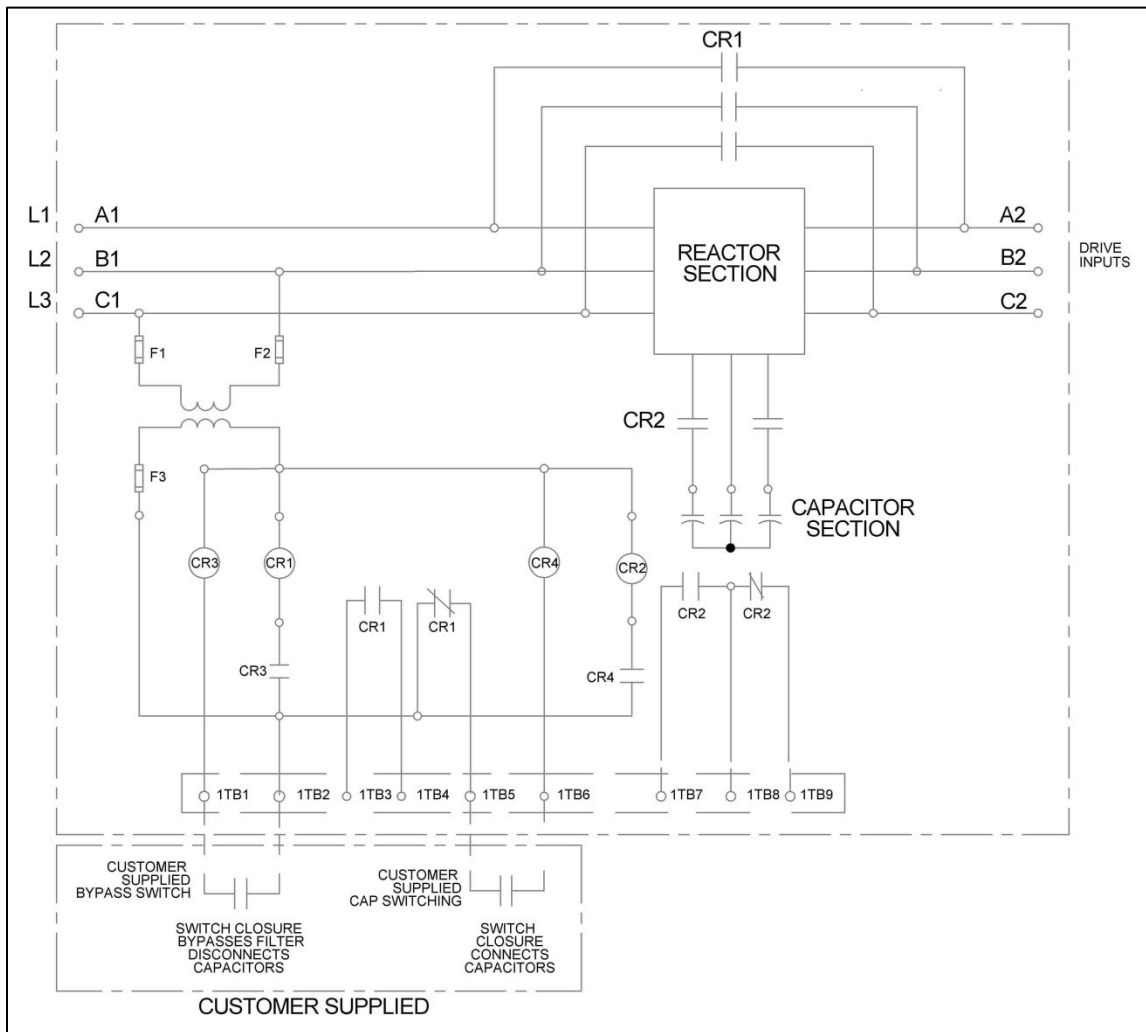

Figure 5-7: Contactor Option – 013

NOTE: The above contactor option diagram is provided to help understand the circuit function and does not reflect actual circuit wiring.

Contactor Coil Switching Currents

Option – 002

The following table indicates the 120 VAC 50/60 Hz current required to switch and hold the various size contactors used in Matrix Filter capacitor switching and bypass options. This data is provided to select the proper switch rating to remotely control the contactor and is consistent for the 208V-240V, 380V-415V, 480V, and 600V units.

Contactor Currents for 120 VAC 60 Hz coils.

Table 5-2: Contactor Coil Switching Currents

Matrix filter current Rating AMPS	Capacitor Contactor Option 002 AMPS	
	<i>INRUSH</i>	<i>SEALED</i>
6	0.341	0.054
8	0.341	0.054
11	0.341	0.054
14	0.341	0.054
21	0.341	0.054
27	0.341	0.054
34	0.341	0.054
44	0.341	0.054
52	0.341	0.054
66	0.341	0.054
83	0.341	0.054
103	0.341	0.054
128	0.922	0.064
165	1.70	0.304
208	1.70	0.304
240	2.00	0.42
320	1.41	0.025
403	1.41	0.025
482	2.08	0.036
636	2.08	0.036
786	3.75	0.036
850	3.75	0.036
1000	3.75	0.036
1200	3.75	0.036



Torque Ratings Matrix AP 208V-240V

Table 5-3: Torque Ratings – 208V-240V

Filter Rating (Amps)	Matrix AP HMR Terminals			Cap-panel Terminals U4-V4-W4		
	Input /Output Power U1-V1-W1 / U2-V2-W2		U4-V4-W4 interconnect Cap-panel	208V-240V Capacitor/ Cap-panel Part Number	Minimum Interconnect Wire Gauge (AWG)	Terminal Torque (in-lbs.)
	Wire Range (AWG)	Terminal Torque (in-lbs.)	Terminal Torque (in-lbs.)			
6	14-6	16	16	CAP-352TP	14	23
8	14-6	16	16	CAP-352TP	14	23
11	14-6	16	16	CAP-366TP	14	23
14	14-6	16	16	CAP-342TP	14	23
21	14-6	16	16	CAP-369TP	14	23
27	14-6	16	16	CAP-356TP	14	23
34	14-6	16	16	CAP-357TP	12	23
44	14-6	16	16	CAP-373TP	12	23
52	14-6	16	16	CAP-374TP	10	23
66	18-4	16	16	CAP-375TP	10	23
83	Flat copper tab	16	16	CAP-377TP	10	23
103	Flat copper tab	16	16	CAP-358TP CAP-359TP	10	23
128	Flat copper tab	16	16	CAP-348TP CAP-358TP	10	23
165	Flat copper tab	16	16	CAP-358TP CAP-376TP	10	23
208	Flat copper tab	16	16	(2) CAP-376TP	8	23
240	Flat copper tab	16	16	CAPPANEL-153	4	60
320	Flat copper tab	16	16	CAPPANEL-154	2	60
403	Flat copper tab	16	16	CAPPANEL-155	2	60

NOTE: Cap-panel interconnect wiring specification according to UL508 75° C Table.

NOTE: To prevent flexing or bending of the coil windings attached to AP HMR Flat copper terminal tabs, use two wrenches to tighten customer provided cable mounting hardware.

Torque Ratings Matrix AP 380V-415V

Table 5-4: Torque Ratings – 380V-415V

Filter Rating (Amps)	Matrix AP HMR Terminals			Cap-panel Terminals U4-V4-W4		
	Input /Output Power U1-V1-W1 / U2-V2-W2		U4-V4-W4 interconnect Cap-panel	380V-415V Capacitor/ Cap-panel Part Number	Minimum Interconnect Wire Gauge (AWG)	Terminal Torque (in-lbs.)
	Wire Range (AWG)	Terminal Torque (in-lbs.)	Terminal Torque (in-lbs.)			
6	14 – 6	16	16	CAP-350TP	14	23
8	14 – 6	16	16	CAP-351TP	14	23
11	14 – 6	16	16	CAP-352TP	14	23
14	14 – 6	16	16	CAP-353TP	14	23
21	14 – 6	16	16	CAP-342TP	14	23
27	14 – 6	16	16	CAP-354TP	14	23
34	14 – 6	16	16	CAP-355TP	12	23
44	18 – 4	16	16	CAP-356TP	12	23
52	Flat copper tab	N/A	16	CAP-357TP	10	23
66	Flat copper tab	N/A	16	CAP-358TP	10	23
83	Flat copper tab	N/A	16	CAP-359TP	10	23
103	Flat copper tab	N/A	16	CAP-360TP	8	23/60
128	Flat copper tab	N/A	16	CAPPANEL-621C	8	60
165	Flat copper tab	N/A	16	CAPPANEL-544C	6	60
208	Flat copper tab	N/A	16	CAPPANEL-543C	4	60
240	Flat copper tab	N/A	16	CAPPANEL-595C	4	60
320	Flat copper tab	N/A	16	CAPPANEL-596C	2	60
403	Flat copper tab	N/A	16	CAPPANEL-597C	1/0	60
482	Flat copper tab	N/A	16	(2) CAPPANEL-595C	4	60
636	Flat copper tab	N/A	16	(2) CAPPANEL- 596C	2	60
786	Flat copper tab	N/A	16	(2) CAPPANEL- 597C	1/0	60
850	Flat copper tab	N/A	16	(2) CAPPANEL- 596C CAPPANEL-595C	2	60
1000	Flat copper tab	N/A	16	(3) CAPPANEL-596C	2	60
1200	Flat copper tab	N/A	16	(3) CAPPANEL-597C	1/0	60

NOTE: Cap-panel numbers designated with “C” as a suffix indicate cap-panels will be either -xxx or -xxxC.

NOTE: Cap-panel interconnect wiring specification according to UL508 75° C Table.

NOTE: To prevent flexing or bending of the coil windings attached to AP HMR Flat copper terminal tabs, use two wrenches to tighten customer provided cable mounting hardware.



Torque Ratings Matrix AP 480V

Table 5-5: Torque Ratings – 480V

Filter Rating (Amps)	Matrix AP HMR Terminals			Cap-panel Terminals U4-V4-W4		
	Input /Output Power U1-V1-W1 / U2-V2-W2		U4-V4-W4 interconnect Cap-panel	480V Capacitor/ Cap-panel Part Number	Minimum Interconnect Wire Gauge (AWG)	Terminal Torque (in-lbs.)
	Wire Range (AWG)	Terminal Torque (in-lbs.)	Terminal Torque (in-lbs.)			
6	14 – 6	16	16	CAP-338TP	14	23
8	14 – 6	16	16	CAP-339TP	14	23
11	14 – 6	16	16	CAP-349TP	14	23
14	14 – 6	16	16	CAP-340TP	14	23
21	14 – 6	16	16	CAP-341TP	14	23
27	14 – 6	16	16	CAP-342TP	14	23
34	14 – 6	16	16	CAP-343TP	12	23
44	18 – 4	16	16	CAP-344TP	12	23
52	Flat copper tab	N/A	16	CAP-345TP	10	23
66	Flat copper tab	N/A	16	CAP-346TP	10	23
83	Flat copper tab	N/A	16	CAP-347TP	10	23
103	Flat copper tab	N/A	16	CAP-348TP	8	23/60
128	Flat copper tab	N/A	16	CAPPANEL-555C	8	60
165	Flat copper tab	N/A	16	CAPPANEL-557C	6	60
208	Flat copper tab	N/A	16	CAPPANEL-545C	4	60
240	Flat copper tab	N/A	16	CAPPANEL-544C	4	60
320	Flat copper tab	N/A	16	CAPPANEL-543C	2	60
403	Flat copper tab	N/A	16	CAPPANEL-562C	1/0	60
482	Flat copper tab	N/A	16	(2) CAPPANEL-544C	4	60
636	Flat copper tab	N/A	16	(2) CAPPANEL-543C	2	60
786	Flat copper tab	N/A	16	(2) CAPPANEL-562C	1/0	60
850	Flat copper tab	N/A	16	(2) CAPPANEL-543C CAPPANEL-544C	2	60
1000	Flat copper tab	N/A	16	CAPPANEL-561C (2) CAPPANEL-543C	2	60
1200	Flat copper tab	N/A	16	(3) CAPPANEL-562C	1/0	60
1600	Flat copper tab	N/A	16	(4) CAPPANEL-563C	1/0	60
2000	Flat copper tab	N/A	16	(5) CAPPANEL-563C	1/0	60
2300	Flat copper tab	N/A	16	(6) CAPPANEL-562C	1/0	60

Torque Ratings Matrix AP 600V

Table 5-6: Torque Ratings – 600V

Filter Rating (Amps)	Matrix AP HMR Terminals			Cap-panel Terminals U4-V4-W4		
	Input /Output Power U1-V1-W1 / U2-V2-W2		U4-V4-W4 interconnect Cap-panel	600V Capacitor/ Cap-panel Part Number	Minimum Interconnect Wire Gauge (AWG)	Terminal Torque (in-lbs.)
	Wire Range (AWG)	Terminal Torque (in-lbs.)	Terminal Torque (in-lbs.)			
6	14 – 6	16	16	CAP-361TP	14	23
8	14 – 6	16	16	CAP-362TP	14	23
11	14 – 6	16	16	CAP-363TP	14	23
14	14 – 6	16	16	CAP-364TP	14	23
21	14 – 6	16	16	CAP-365TP	14	23
27	14 – 6	16	16	CAP-366TP	14	23
34	14 – 6	16	16	CAP-367TP	12	23
44	18 – 4	16	16	CAP-368TP	12	23
52	Flat copper tab	N/A	16	CAP-369TP	10	23
66	Flat copper tab	N/A	16	CAP-370TP	10	23
83	Flat copper tab	N/A	16	CAP-371TP	10	23
103	Flat copper tab	N/A	16	CAPPANEL-567C	8	23/60
128	Flat copper tab	N/A	16	CAPPANEL-568C	8	60
165	Flat copper tab	N/A	16	CAPPANEL-570C	6	60
208	Flat copper tab	N/A	16	CAPPANEL-572	4	60
240	Flat copper tab	N/A	16	CAPPANEL-574C	4	60
320	Flat copper tab	N/A	16	CAPPANEL-576C	2	60
403	Flat copper tab	N/A	16	CAPPANEL-578C	1/0	60
482	Flat copper tab	N/A	16	(2) CAPPANEL-574C	4	60
636	Flat copper tab	N/A	16	(2) CAPPANEL-576C	2	60
786	Flat copper tab	N/A	16	(2) CAPPANEL-578C	1/0	60

NOTE: Cap-panel numbers designated with “C” as a suffix indicate cap-panels will be either -xxx or -xxxC.

NOTE: Cap-panel interconnect wiring specification according to UL508 75° C Table.

NOTE: To prevent flexing or bending of the coil windings attached to AP HMR Flat copper terminal tabs, use two wrenches to tighten customer provided cable mounting hardware.



Torque Ratings Matrix AP 690V

Table 5-7: Torque Ratings – 690V

Filter Rating (Amps)	Matrix AP HMR Terminals			Cap-panel Terminals U4-V4-W4		
	Input /Output Power U1-V1-W1 / U2-V2-W2		U4-V4-W4 interconnect Cap-panel	690V Capacitor/ Cap-panel Part Number	Minimum Interconnect Wire Gauge (AWG)	Terminal Torque (in-lbs.)
	Wire Range (AWG)	Terminal Torque (in-lbs.)	Terminal Torque (in-lbs.)			
52	4 - 14	N/A	16	CAPPANEL-622C	12	60
66	Flat copper tab	N/A	16	CAPPANEL-612	10	60
83	Flat copper tab	N/A	16	CAPPANEL-613	10	60
103	Flat copper tab	N/A	16	CAPPANEL-615C	8	60
128	Flat copper tab	N/A	16	CAPPANEL-617C	8	60
165	Flat copper tab	N/A	16	CAPPANEL-619C	8	60
208	Flat copper tab	N/A	16	CAPPANEL-614C CAPPANEL-616	8	60
240	Flat copper tab	N/A	16	CAPPANEL-616 CAPPANEL-617C	8	60
320	Flat copper tab	N/A	16	(2) CAPPANEL-618C	6	60
403	Flat copper tab	N/A	16	(2) CAPPANEL-618C CAPPANEL-614C	8	60
482	Flat copper tab	N/A	16	(3) CAPPANEL-618	6	60
636	Flat copper tab	N/A	16	CAPPANEL-620 (2) CAPPANEL-621C	4	60

NOTE: Cap-panel numbers designated with “C” as a suffix indicate cap-panels will be either -xxx or -xxxC.

NOTE: Cap-panel interconnect wiring specification according to UL508 75° C Table.

NOTE: To prevent flexing or bending of the coil windings attached to AP HMR Flat copper terminal tabs, use two wrenches to tighten customer provided cable mounting hardware.

6. START-UP

Safety Precautions



Before start-up, observe the following warnings and instructions:

 WARNING	<p>Internal components of the filter are at line potential when the filter is connected to the drive. This voltage is extremely dangerous and may cause death or severe injury if you come in contact with it.</p>
	<p>Remove all power to the Matrix AP filter in compliance to standardized 26 CFR 1920.147 lockout/tagout policies. After disconnecting the utility power, wait at least 5 minutes before doing any work on the filter connections. After removing power, allow at least five minutes to elapse and verify that the capacitors have discharged to a safe level before contacting internal components. Connect a DC voltmeter across the capacitor terminals and ensure that the voltage is at a safe level.</p>
	<p>Use extreme caution to avoid contact with line voltage when checking for power. INJURY OR DEATH MAY RESULT IF SAFETY PRECAUTIONS ARE NOT OBSERVED.</p>
	<p>After disconnecting the utility power, wait at least 5 minutes before doing any work on the filter connections. After removing power, allow at least five minutes to elapse and verify that the capacitors have discharged to a safe level before contacting internal components. Connect a DC voltmeter across the capacitor terminals. Start with the meter on the highest scale and progressively switch to a lower scale as the indicated voltage falls below the maximum value of the scale used.</p>

Sequence of Operation

1. Read and follow safety precautions.
2. After installation, ensure that:
 - All filter ground terminals are connected to ground.
 - Power wiring to the utility, drive and motor is in accordance with the power wiring connection diagrams shown in installation instructions section.
 - Use the following guidelines for power and cap-panel wire gauges:
 - Table 5-3: Torque Ratings – 208V-240V (p38)
 - Table 5-4: Torque Ratings – 380V-415V (p39)
 - Table 5-5: Torque Ratings – 480V (p40)
 - Table 5-6: Torque Ratings – 600V (p41)
 - Table 5-7: Torque Ratings – 690V (p42)
3. Check that moisture has not condensed on the filter components. If moisture is present, do not proceed with start-up until the moisture has been removed.
4. Disconnect the filter output from the drive.
5. Connect the filter to the utility.
6. Confirm that line voltage is present at the input terminals (U, V1, W1) of the filter.
7. Confirm that line voltage is present at the output terminals (U2, V2, W2) of the filter and that it is less than or equal to 1.05 times the input voltage.
8. Using a clamp on Amp meter, check input phase currents to verify they are within a 5% match to each other and approximately 30% of filter current rating.
9. Remove power and verify that **NO VOLTAGE** is present on the filter terminals.
10. Connect the filter output to the drive.
11. Refer to the drive user manual for the drive start-up procedure. Observe all safety instructions in the drive user manual.

7. TROUBLESHOOTING

 WARNING	<p>When properly installed, this equipment has been designed to provide maximum safety for operating personnel. However, hazardous voltages and elevated temperatures exist within the confines of the enclosure. Servicing should therefore be performed by qualified personnel only and in accordance with OSHA Regulations.</p>
	<p>High voltage is used in the operation of this filter. Use Extreme caution to avoid contact with high voltage when operating, installing or repairing this filter. INJURY OR DEATH MAY RESULT IF SAFETY PRECAUTIONS ARE NOT OBSERVED.</p>
 CAUTION	<p>After removing power, allow at least five minutes to elapse and verify that the capacitors have discharged to a safe level before contacting internal components. Connect a DC voltmeter across the capacitor terminals or terminals U1, V1 or V1, W1 and ensure that the voltage is at a safe level.</p>

To aid in troubleshooting, a basic schematic diagram, two interconnection diagrams, and a trouble shooting guide that lists potential problems and solutions are included:

Figure 5-1: Basic Schematic Diagram (p30)

Figure 5-2: Open Panel Interconnection (p31)

Figure 5-3: Enclosed Interconnection (p32)

Table 7-1: Troubleshooting Guide (p47)

Matrix AP Harmonic Filter Field Checks

1. Disconnect all power and remove input power wiring from U1, V1, W1 terminals.
2. Remove VFD drive power connections from filter terminals U2, V2, W2 and any contactor or temperature switch wiring. (For filters using control transformers: remove power fuses on top of transformer.)
3. Visually inspect filter terminals and wiring lugs for signs of heat and corrosion. **Contact factory if any wires appear to be missing or cut!**
4. Inspect the U4, V4, W4 capacitor interconnect terminals and wiring.
5. Visually inspect all capacitors for signs of case deformation, bowing of the top, leaking oil or terminal damage. Note the CAP- # and date code of any damaged capacitors.
6. Using a multi meter set to read 100K ohms check:
 - a. Phase to phase U1-V1-W1-U1 (mechanically activate contactor if present) after reactor and caps charge reading should be about 40K (total equivalent breeder resistance value) and should be the same for each phase. Open circuit or very low readings indicate a problem.
 - b. Phase to chassis U1- case, V1-case, W1- case; low readings indicate a ground fault problem.
7. Ensure the “disconnect” is safe, then wire the utility power to U1, V1, W1.
8. Apply power and verify that proper output voltage is present on U2, V2, and W2.
9. Using a clamp on amp meter read the filter input current:
 - a. Readings will be 0.5 of the capacitor current listed in Table 3-2: Watt Loss - Matrix AP 208V-240V, 60Hz (p6) (208V-240V), Table 3-3: Watt Loss - Matrix AP 380V-415V, 50Hz (p7) (380V-415V), Table 3-4: Watt Loss - Matrix AP 480V, 60Hz (p8) (480V), Table 3-5: Watt Loss - Matrix AP 600V, 60Hz (p9) (600V) and Table 3-6: Watt Loss - Matrix AP 690V, 50Hz (p10) (690V) for the listed filter current in the user manual (mechanically activate the contactor if the filter is equipped with one). Readings should be the same (+/- 5%) for all phase currents; **contact the factory if currents are out of tolerance!**
 - b. Open contactor readings will show zero current for all phases.
10. Disconnect filter power and wire the VFD to U2, V2, and W2 as well as any control wiring to the filter contactor or temperature switch. Replace any control transformer fuses. Follow the drive power start-up guidelines in the drive manufacturer’s user manual.

Table 7-1: Troubleshooting Guide

PROBLEM:	Line voltage is not present at the filter output terminals.
Possible cause:	Power to the filter is turned off.
Solution:	Turn power on.
Possible cause:	One or more external line fuses are blown.
Solution:	Verify the continuity of line fuses in all phases. Replace as necessary.
PROBLEM:	Full Load Harmonic current distortion exceeds 5% on one or more phases at full load.
Possible cause:	The capacitor assembly has not been connected.
Solution:	Check interconnection of capacitor assembly per the following: Figure 5-1: Basic Schematic Diagram (p30) Figure 5-2: Open Panel Interconnection (p31) Figure 5-3: Enclosed Interconnection (p32)
Possible cause:	A capacitor has failed.
Solution:	Inspect the tops of all capacitors for bowing. Replace failed capacitors.
Possible cause:	Source impedance is less than 1.5%.
Solution:	Add a minimum 1.5% impedance line reactor to the filter input.
Possible cause:	Input source voltage harmonic distortion.
Solution:	Identify equipment causing harmonic voltage distortion and add filters as required or accept elevated THVD.
Possible cause:	Line voltage unbalance exceeds 1%.
Solution:	Balance input line voltage to 1% or less.
PROBLEM:	Filter output voltage is not within specification
Possible cause:	Filter input voltage is not within specification.
Solution:	Check the AC input line voltage and verify that it is within tolerance. Refer to the filter service conditions and performance specifications for tolerances.
Possible cause:	Source impedance is out of tolerance.
Solution:	Verify that the source impedance is within tolerance. Refer to the filter service conditions and performance specifications for tolerances.
Possible cause:	Source impedance is out of tolerance.
Solution:	Verify that the source impedance is within tolerance. Refer to the filter service conditions and performance specifications for tolerances.
Possible cause:	One or more Capacitors is damaged.
Solution:	Visually check capacitor top for distortion or doming. Check for shorts or open caps. Replace failed capacitors.
Possible cause:	Drive set up parameter does not allow for input filter
Solution:	Consult drive manufacturer to update set-up to accommodate input filter.
Possible cause:	Input voltage subject to extreme transients such as switching between two voltage sources. Drive faults on over or under voltage.
Solution:	Source switching is not recommended without proper phase synchronizing or allowing reasonable time delay before transfer to new source.